

# SITAG CABINETS



**SITAG**  
swiss style at work



Mit SITAG Stauraummöbeln lösen Sie jede Möblierungsaufgabe. Vom Arbeitsplatz über das Archiv bis zum Chefzimmer, mit fast grenzenlosen Material-, Farb- und Oberflächenvarianten.

**| D | AUF DEN FOLGENDEN SEITEN** zeigen wir an Hand eines Planungsszenarios, wie vielfältig die Möglichkeiten sind, die die Stauraummöbel der SITAG bieten. Qualität auch im Detail, raffinierte Konzepte und kundenorientierte Lösungen sind ihre Merkmale. Wo Serienlösungen aus der umfangreichen Modell- und Materialpalette nicht reichen, ist die SITAG auch Spezialist für modifizierte Serienfertigung oder auch individuelle Einzelfertigung.

**| E | SITAG CABINETS** help you to solve any task involving office storage furniture. They range from workplaces to archiving and to executive offices – with a virtually unlimited selection of furniture materials, colours, and surface finishes. On the following pages we use a planning scenario to show you the many and various possibilities that office storage furniture from SITAG offers you. These models are distinguished by quality down to the last detail, sophisticated concepts, and customer-oriented solutions. In cases in which series-production solutions from its extensive model and material portfolios do not suffice, SITAG is also the specialist for modified series production as well as customized, individual offerings.

**| F | LE MOBILIER DE RANGEMENT DE SITAG** est la réponse à tous vos soucis d'ameublement. Du poste de travail au bureau de direction en passant par les archives moyennant un choix quasi illimité de matériaux, de coloris et de finitions. Prenant appui sur un scénario de planification, les pages suivantes vous proposent une multitude de solutions de rangement signées SITAG. Elles se distinguent par la qualité et, le soin apporté aux détails, les concepts aboutis et centrés sur les clients. Dans tous les cas de figure où les solutions de série issues d'un large éventail de modèles et de matériaux paraîtraient irréalisables, SITAG est spécialisé également dans la fabrication en série modifiée ou dans la fabrication de solutions personnalisées.

**| I | CON I MOBILI PER RIPONIMENTO SITAG** si può soddisfare ogni esigenza di arredamento. Dalla postazione di lavoro in ufficio all'archivio fino alla stanza del capo, attingendo ad una varietà quasi inesauribile di materiali, colori e finiture. Alle pagine seguenti illustriamo, sulla base di uno scenario di progettazione, le molteplici opportunità offerte dai mobili per riponimento SITAG che si distinguono per un'eccellente qualità, anche nei dettagli, idee raffinate e soluzioni orientate al cliente. Laddove le soluzioni di serie offerte dalla vasta gamma di modelli e materiali non dovessero bastare, SITAG dimostra grande flessibilità modificando la produzione di serie o impostandola su esigenze individuali.

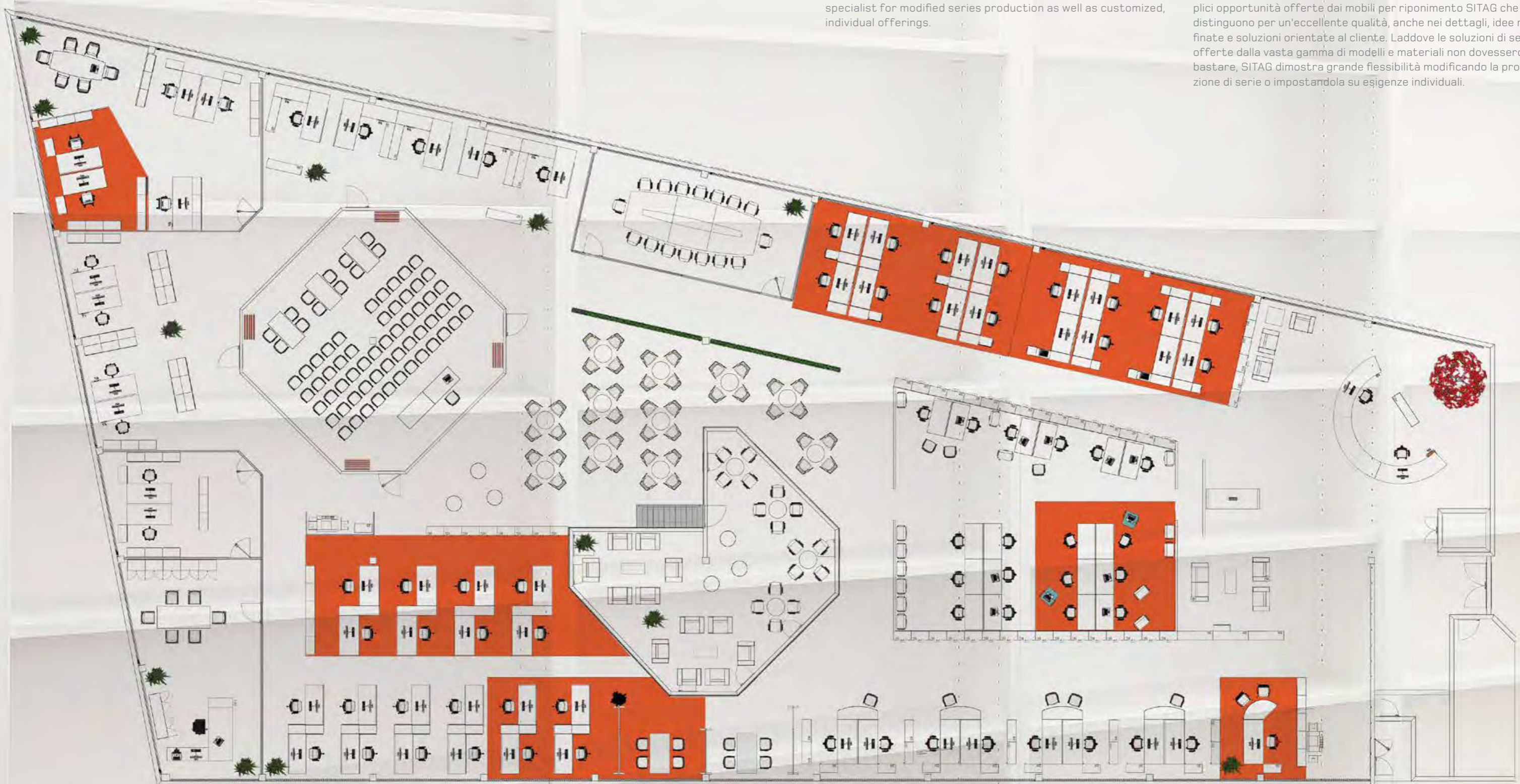

# SITAG CABINETS

## SITAG SCHRANKPROGRAMM The SITAG cabinet collection | Gamme d'armoires de SITAG | Programma di armadi SITAG

**SCHIEBETÜRENSCHRÄNKE /  
ROLLLADENSCHRÄNKE:**  
Sliding-door cabinets / Roller-  
shutter cabinets | Armoires à  
portes coulissantes / Armoires à  
rideaux | Armadi con ante scorre-  
voli / Armadi a tapparella



**DETAILS** | Details | Détails | Dettagli  
**SEITE 16**

**ÜBERSICHT** | Overview | Vue d'ensemble |  
Quadro d'insieme  
**SEITE 20**

**SEITE 6**

**Z-SCHIEBETÜRENSCHRÄNKE**  
Z-sliding-door cabinets |  
Armoires à portes coulissantes  
en z | Armadi con ante  
scorrevoli z  
**SEITE 22**



**DETAILS** | Details | Détails | Dettagli  
**SEITE 26**

**ÜBERSICHT** | Overview | Vue d'ensemble | Quadro d'insieme  
**SEITE 27**

## SITAG ORGATOWER

**ORGATOWER**  
**SEITE 28**



**ORGATOWER BASIC**  
**SEITE 32**



**ORGATOWER LIGHT**  
**SEITE 32**



**DETAILS** | Details | Détails | Dettagli  
**SEITE 38**

**ÜBERSICHT** | Overview | Vue d'ensemble | Quadro d'insieme  
**SEITE 39**

## SITAG MCS SCHRANKSYSTEM

SITAG MCS CABINET SYSTEM | ARMOIRES SYSTÈMES SITAG MCS |  
SISTEMA PER ARMADIO SITAG MCS

**MCS SCHRANKSYSTEM**  
MCS cabinet system | armoires  
systèmes MCS | sistema per  
armadio MCS  
**SEITE 40**



**DETAILS** | Details | Détails | Dettagli  
**SEITE 52**

**ÜBERSICHT** | Overview | Vue d'ensemble | Quadro d'insieme  
**SEITE 56**

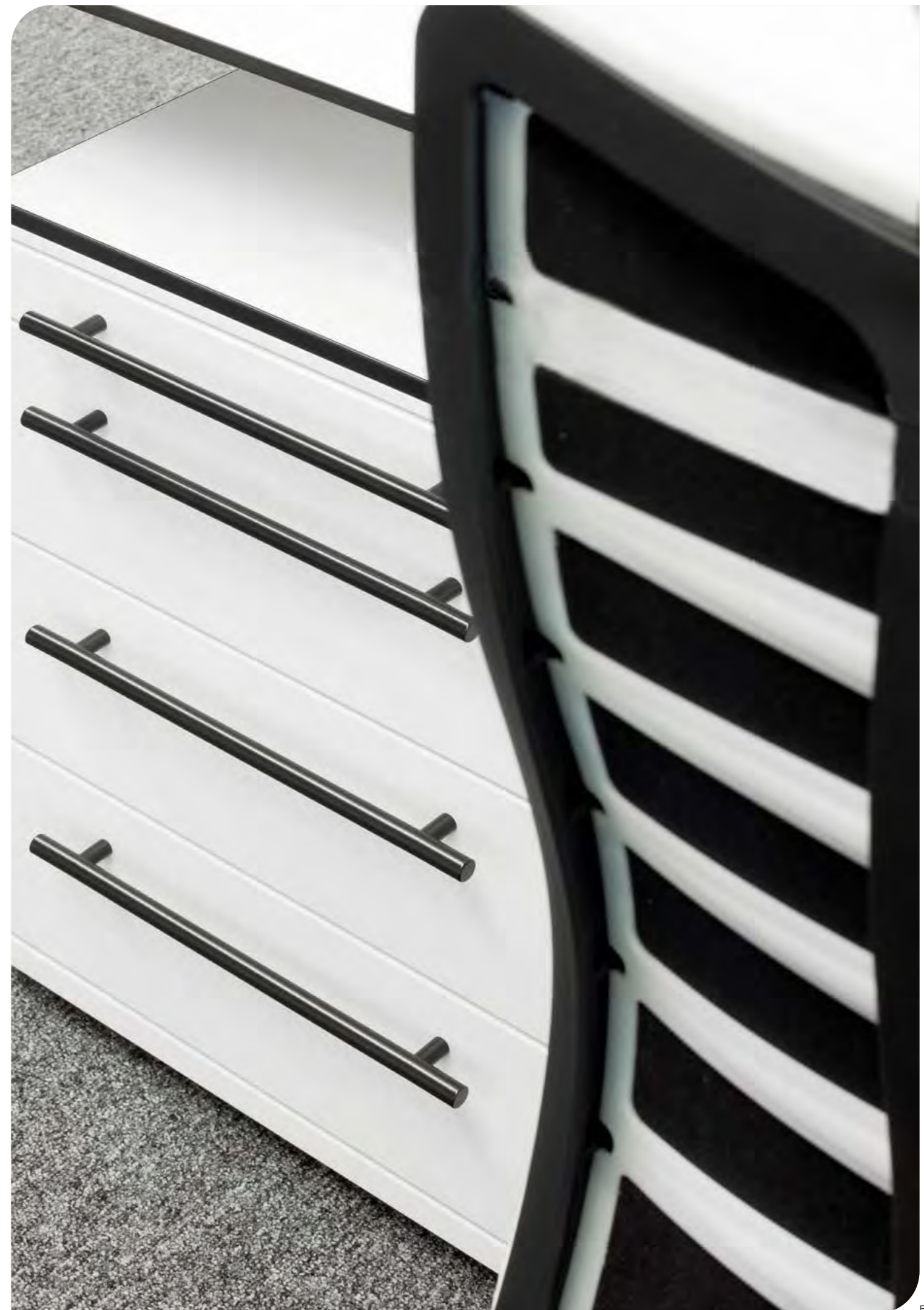

# SITAG SCHRANKPROGRAMM

The SITAG cabinet collection | Gamme d'armoires de SITAG | Programma di armadi SITAG

SITAG SCHRANKPROGRAMM – das vielseitige Stauraumsystem mit einer grossen Auswahl an Korpussen, Ordnergestellen, Drehtüren-schränken, Rollladenschränken, Auszugs-schränken, Registraturschränken und Caddys bietet auch in zahlreichen Oberflächen und Griffvarianten eine umfassende Auswahl.

**| E | THE SITAG CABINET COLLECTION** – the versatile office storage furniture system – with an extensive selection of outer furniture shells, lever-binder cabinets, hinged-door cabinets, roller-shutter cabinets, pull-out cabinets, filing cabinets, and pedestals – offers an extensive choice in numerous surface finishes and handle versions.

**| F | LA GAMME D'ARMOIRES DE SITAG**, le système de rangement à usage multiple constitué d'un grand choix de corps de meuble, de bibliothèques, d'armoires à portes battantes, d'armoires à rideaux, d'armoires à tiroirs, d'armoires de classement et de caddys, propose également une grande variété de finitions et de poignées.

**| I | PROGRAMMA DI ARMADI SITAG** – Il versatile sistema di riponimento offre una grande scelta di elementi modulari, scaffalature per raccoglitori, armadi a porte girevoli, armadi a tapparella, armadi estraibili, armadi archivio e cassettiere su rotelle nonché un'ampia gamma di finiture e varianti di maniglie.

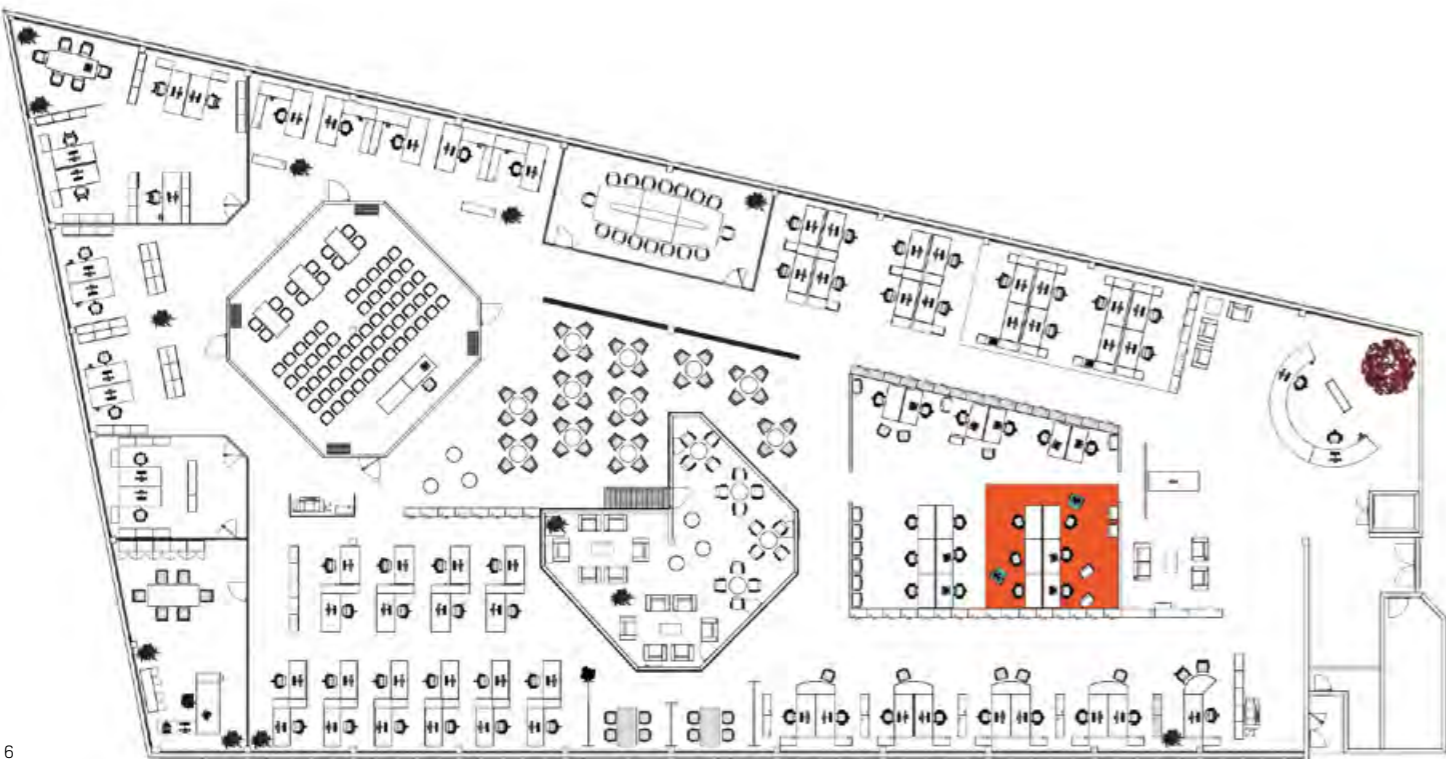

# SITAG SCHRANKPROGRAMM

The SITAG cabinet collection | Gamme d'armoires de SITAG | Programma di armadi SITAG



# SITAG SCHRANKPROGRAMM

The SITAG cabinet collection | Gamme d'armoires de SITAG | Programma di armadi SITAG



# SITAG SCHRANKPROGRAMM

The SITAG cabinet collection | Gamme d'armoires de SITAG | Programma di armadi SITAG



# SITAG SCHRANKPROGRAMM

The SITAG cabinet collection | Gamme d'armoires de SITAG | Programma di armadi SITAG

## VORTEILE UND NUTZEN

Advantages and benefits | Avantages et bénéfices | Utilità e vantaggi

### | D | SITAG SCHRANKPROGRAMM

- kombinierbar mit SITAG-Tischprogrammen, frei im Raum als Raumgliederung oder als Wandschränkkombination
- hochwertig verleimtes Gehäuse
- Verarbeitung mit umweltfreundlichen Polypropylen-Kanten, die mit Lasertechnologie aufgezogen werden. Somit entsteht eine optische Nullfuge
- Wechselzylindersystem für hohe Flexibilität
- Stauraummöbel werden immer komplett montiert geliefert für minimalen Montageaufwand vor Ort
- grosse Auswahl an verschiedenen Stauraumschränken
- hoch qualitative Verarbeitung
- durch die Plattenstärken der horizontalen Werkteile von 22 mm ist eine hohe Belastung möglich
- die Flügeltürschränke können auch als Garderobenschränke bestellt werden.

### | E | SITAG CABINET COLLECTION

- can be combined with SITAG desk collections – either as open in a room, as room subdividers, or in combination with wall cabinets
- high-quality, laminated enclosures
- crafted with environmentally friendly polypropylene edges, that are fitted on with laser systems – resulting in an optical zero joint
- interchangeable cylinder-lock system for great flexibility
- office storage furniture is always delivered completely assembled, for a minimum of installation work onsite
- extensive selection of many different office storage cabinets
- high-quality craftsmanship
- great loadbearing capability owing to the thickness (22 mm) of the horizontal components
- hinged-door cabinets that can also be ordered as coat cabinets.

### | F | GAMME D'ARMOIRES DE SITAG

- combinable avec les collections de tables SITAG, installation en îlot à titre de structuration ou d'armoire murale combinée
- collage exclusif des corps de meuble
- chants PP de conception écologique montés au laser. Jointage invisible
- système de serrures à cylindre extractible pour davantage de souplesse
- mobilier de rangement livré entièrement monté pour un minimum d'installation sur place
- grande variété d'armoires de rangement
- finition de qualité exclusive
- pièces horizontales d'une épaisseur de panneau de 22 mm pour une haute résistance
- les armoires à portes battantes peuvent être conçues également sous forme de penderie.

### | I | PROGRAMMA DI ARMADI SITAG

- abbinabile a programmi di tavoli SITAG, come gruppo divisorio entro lo spazio del locale o come combinazione tavolo-armadio a parete
- corpo esterno incollato con processo di alta qualità
- lavorazione con ecologici bordi in polipropilene applicati con tecnologia laser rendendo invisibile la giuntura
- sistema di cilindri intercambiabili per un'ottima flessibilità
- i mobili per riponimento vengono consegnati sempre montati completamente riducendo al minimo il lavoro di montaggio sul posto
- grande scelta di armadi di riponimento
- Lavorazione di alta qualità
- grazie ai 22 mm di spessore delle lastre dei pezzi orizzontali gli elementi sono in grado di sostenere carichi elevati
- gli armadi con ante a battente possono essere ordinati anche come armadi guardaroba.





# SITAG SCHRANKPROGRAMM: DIE DETAILS

The SITAG cabinet collection: the details | Gamme d'armoires de SITAG: les détails | Programma di armadi SITAG: i dettagli

## BEISTELL- UND UNTERSTELLKORPUSSE

| D | In verschiedenen Höhen und Aufteilungen erhältlich, Standard auf Nivellier-Gleitern, auch auf Rollen erhältlich.

| E | Side and underdesk pedestals. Available in various heights and subdivisions; standard version on height-adjustment glider feet, but also mounted on castors if desired.

| F | Meubles d'appoint et caissons. Livrables en différentes hauteurs et subdivisions, de série avec patins ou avec roulettes.

| I | Elementi sottostanti e accostabili. Disponibili in altezze e ripartizioni diverse, versione standard con piedini di livellamento, disponibili anche su rotelle.



## REGISTRATUR-SCHRÄNKE

| D | In verschiedenen Höhen und Aufteilungen erhältlich.

| E | Filing cabinets. Available in various heights and subdivisions.

| F | Armoires de classement Disponibles en différentes hauteurs et subdivisions.

| I | Armadi archivio. Disponibili in altezze e ripartizioni diverse.



## MATERIALSCHIEBER

| E | Material drawer

| F | Organisateur de tiroir

| I | Cassetto per materiali vari

## SCHRÄGFÄCHER

| E | Slanted divider drawer

| F | Casiers inclinés

| I | Cassetto con scomparti obliqui

## TRENNSCHIED

| E | Compartment drawer

| F | Séparation pour tiroir

| I | Cassetto con divisorio interno

## HÄNGEREGISTERSCHUBLADE

| E | File-hanger drawer

| F | Tiroir pour dossiers suspendus

| I | Cassetto per cartelle sospese



## GRIFFVARIANTEN

| E | Selection of handles | F | Poignées | I | Varianti di maniglie

| D | Stangengriff

| E | T-bar handle

| F | Poignée tige

| I | Maniglia a sbarra

| D | C-Griff

| E | Bow-type handle

| F | Poignée carrée coudée

| I | Maniglia ad archetto

| D | Lisenengriff

| E | L-section pull handle

| F | Poignée lésène

| I | Presa a lesena

| D | Muschelgriff

| E | Recessed handle

| F | Poignée coquille

| I | Maniglia incassata



# SITAG SCHRANKPROGRAMM: DIE DETAILS

The SITAG cabinet collection: the details | Gamme d'armoires de SITAG: les détails | Programma di armadi SITAG: i dettagli



## ROLLLADENSCHRÄNKE

- | D | Mit durchdachter Griffleiste für optimale Qualität und Laufeigenschaften.
- | E | Roller-shutter cabinets. With especially designed handles for optimal quality and sliding properties.
- | F | Armoires à rideaux. Support de poignée bien pensé pour une qualité et des propriétés mécaniques optimales.
- | I | Armadi a tapparella. Con maniglia realizzata appositamente per una qualità e scorrevolezza ottimali.



## SCHIEBETÜRENSCHRÄNKE

- | E | Sliding-door cabinets
- | F | Armoires à portes coulissantes
- | I | Armadi con ante scorrevoli



## FLÜGELTÜRENSCHRÄNKE

- | D | Drehbarkeit 270 Grad, mit Stangenschloss.
- | E | Hinged-door cabinets. Can be swivelled 270 °; with rod lock.
- | F | Armoires à portes battantes. Angle d'ouverture 270°, fermeture à espagnolette.
- | I | Armadi con ante a battente. Rotabilità a 270°, con serratura a cariglione.



## OFFENE REGALE

- | D | Bohrungen für Nachbestückung mit Flügeltüren.
- | E | Open cabinets. With holes drilled for retrofitting with hinged doors.
- | F | Étagères ouvertes. Alésages pour portes battantes en équipement évolutif.
- | I | Scaffali aperti. Fori per montaggio a posteriori di ante a battente.



## GARDEROBENSCHRÄNKE

- | E | Coat cabinets
- | F | Penderies
- | I | Armadi guardaroba



- | D | Türband Öffnungswinkel 270 Grad.
- | E | Opening angle of door hinge: up to 270 °.
- | F | Charnière angle d'ouverture 270°.
- | I | Angolo di apertura della cerniera 270°.



- | D | Alle Schränke mit Wechselzylinder ausgestattet.
- | E | All cabinets are fitted with interchangeable cylinder-lock systems.
- | F | Armoires toutes équipées de serrures à cylindre extractible.
- | I | Tutti gli armadi sono dotati di cilindri intercambiabili.



- | D | Tablarträger eingefräst und fixiert, trotzdem verstellbar für optimale Stabilität und Benutzerfreundlichkeit.
- | E | Shelf supports counter-bored and permanently mounted – but can be adjusted for optimal stability and user convenience.
- | F | Supports d'étagère fraisés et fixés, réglables en vue d'une stabilité et d'une convivialité optimales.
- | I | Porta-ripiani fresato e fissato eppure regolabile per garantire ottimale stabilità e comodità d'uso.



- | D | Alle Schränke mit Sichrückwand für optimale Ästhetik, gleichgültig ob an der Wand oder frei im Raum.
- | E | All cabinets are with attractive back panels for optimal aesthetics, whether facing the wall or open in a room.
- | F | Armoires toutes dotées d'un panneau arrière de parement en vue d'une esthétique parfaite, quel que soit l'emplacement adossé au mur ou en îlot.
- | I | Tutti gli armadi sono realizzati con pannello a vista rivestito per un'ottimale estetica, indipendentemente dal fatto che si tratti di versioni a parete o da installare nello spazio del locale. Possibilità di dotazione di elementi fonoassorbenti sottili e tali da potervi appuntare informazioni o simili.



# SITAG SCHRANKPROGRAMM: IM ÜBERBLICK

The SITAG cabinet collection: overview | Gamme d'armoires de SITAG: vue d'ensemble | Programma di armadi SITAG: quadro d'insieme

## 2 OH\*

Höhe 74,4 cm

Offenes Regal  
Open shelves | Étagère ouverte |  
Scaffale aperto

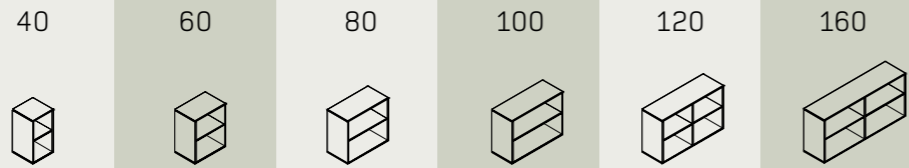

Flügeltürenschränk

Hinged-door cabinet | Armoire à portes  
battantes | Armadio con ante a battente



Rollladenschränk

Roller-shutter cabinet | Armoire à rideaux |  
Armadio a tapparella



Schiebetürenschränk

Sliding-door cabinet | Armoire à portes  
coulissantes | Armadio con ante scorrevoli



## 3 OH\*

Höhe 115,5 cm

Offenes Regal  
Open shelves | Étagère ouverte |  
Scaffale aperto



Flügeltürenschränk

Hinged-door cabinet | Armoire à portes  
battantes | Armadio con ante a battente



Rollladenschränk

Roller-shutter cabinet | Armoire à rideaux |  
Armadio a tapparella

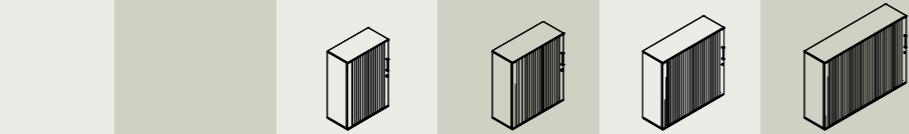

Schiebetürenschränk

Sliding-door cabinet | Armoire à portes  
coulissantes | Armadio con ante scorrevoli



## 4 OH\*

Höhe 148,7 cm

Offenes Regal  
Open shelves | Étagère ouverte |  
Scaffale aperto

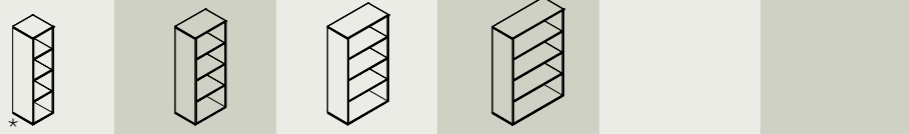

Flügeltürenschränk

Hinged-door cabinet | Armoire à portes  
battantes | Armadio con ante a battente

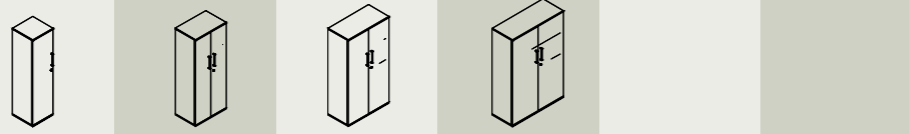

Trennwände

Partitions | Cloisons | Pareti divisorie



\*Ordnerhöhe = lever-binder height = hauteur de classeurs = altezza raccoglitori

## 5 OH\*

Höhe 188,7 cm

Offenes Regal  
Open shelves | Étagère ouverte |  
Scaffale aperto

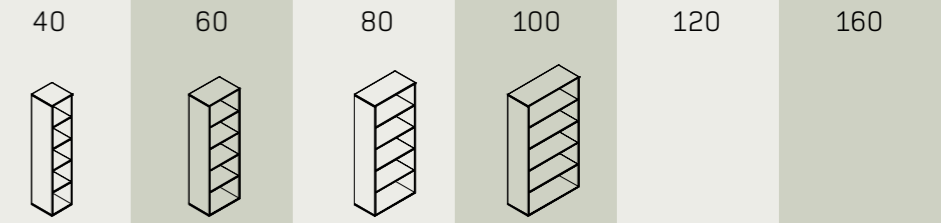

Flügeltürenschränk

Hinged-door cabinet | Armoire à portes  
battantes | Armadio con ante a battente

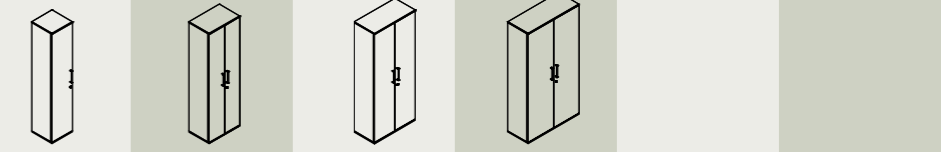

Trennwände

Partitions | Cloisons | Pareti divisorie



## 6 OH\*

Höhe 229,7 cm

Offenes Regal  
Open shelves | Étagère ouverte |  
Scaffale aperto

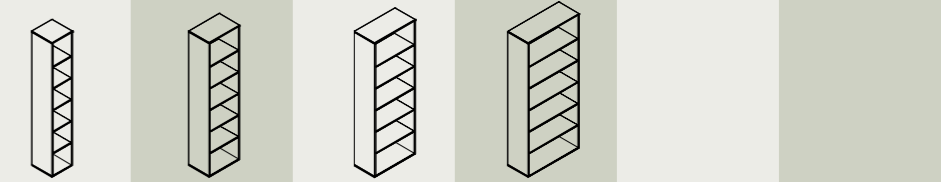

Flügeltürenschränk

Hinged-door cabinet | Armoire à portes  
battantes | Armadio con ante a battente

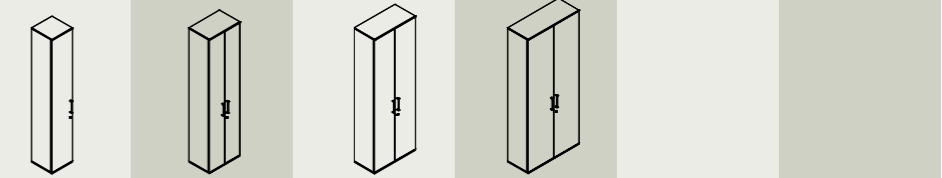

## KORPUSSE

Unterstellkorp

Underdesk pedestal | Caisson | Elemento  
sottostante

Höhe 51.5 cm



Unterstellkorp

Underdesk pedestal | Caisson | Elemento  
sottostante

Höhe 55.5 cm



Unterstellkorp

Underdesk pedestal | Caisson | Elemento  
sottostante

Höhe 60 cm



Anstellkorp

Side pedestal | Caisson juxtaposé | Elemento  
accostabile

Höhe 72 /74,5 cm



## REGISTRATUR

Filing cabinets | Classement | Archivio

### 2 OH\*

Höhe 74,4 cm



## REGISTRATUR

Filing cabinets | Classement | Archivio

### 3 OH\*

Höhe 115,5 cm



40 tief

profondeur 40  
40-cm depth  
profondità 40

60 tief

profondeur 60  
60-cm depth  
profondità 60

80 tief

profondeur 100  
100-cm depth  
profondità 100

# SITAG Z-SCHIEBETÜRSCHRANK

SITAG z-sliding-door cabinet | Armoire à portes coulissantes en z de SITAG | Armadio con ante scorrevoli z SITAG

Die Z-Schiebetürschränke aus dem SITAG SCHRANKPROGRAMM sind eine platzsparende Möglichkeit, Arbeitsplätze zu möblieren. Sie bieten nicht nur mehr Ablagemöglichkeiten im persönlichen Erstzugriff, sondern machen auch verbesserte Akustik und mehr Privatsphäre am Arbeitsplatz möglich. Die Schränke gibt es mit rechts- oder linksöffnenden Türen, verschiedenen Höhen und mit einer grossen Auswahl an Ausstattungsmöglichkeiten. In der Ausführung mit „Bulletin Board“ lassen sich die Türen als praktische Pinnwand benutzen.

**| E |** THE Z-SLIDING-DOOR CABINETS from the SITAG cabinet collection offer the possibility to save space when furnishing workplaces. They not only offer more stowage possibilities for immediate personal access: they also enable enhanced acoustics and greater privacy at the workplace. The cabinets are available with doors opening to the right or to the left, with various heights, and with a large selection of furnishing options. In the Bulletin Board version, the cabinet doors can be used as handy pinboards.

**| F |** LES ARMOIRES À PORTES COULISSANTES EN Z issues de la gamme d'armoires de SITAG sont des solutions d'aménagement peu encombrantes. Outre les possibilités de rangements supplémentaires à portée de main, elles offrent une meilleure acoustique et davantage d'espace privatif au bureau. Les portes s'ouvrent à gauche ou à droite, il y a différentes hauteurs et un large choix d'équipements. Le modèle «Bulletin Board» offre des portes d'affichage bien pratiques.

**| I |** GLI ARMADI CON ANTE SCORREVOLI Z del programma di armadi SITAG permettono di ammobiliare posti di lavoro risparmiando spazio e offrono non solo più possibilità di tenere materiali utili a portata di mano ma contribuiscono anche a migliorare l'acustica e la privacy. Gli armadi sono disponibili con ante apribili verso destra o verso sinistra, in diverse altezze e con una grande scelta di opzioni arredative. Nella versione con "bacheca", le ante possono essere usate come pratico pannello su cui appuntare notizie e informazioni varie.



# SITAG Z-SCHIEBETÜRSCHRANK

SITAG z-sliding-door cabinet | Armoire à portes coulissantes en z de SITAG | Armadio con ante scorrevoli z SITAG

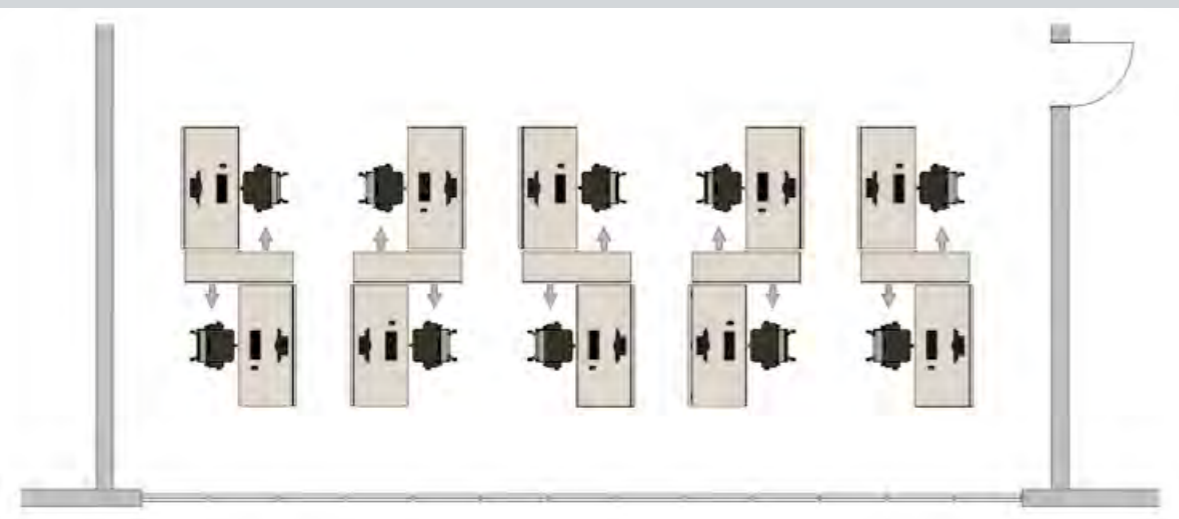
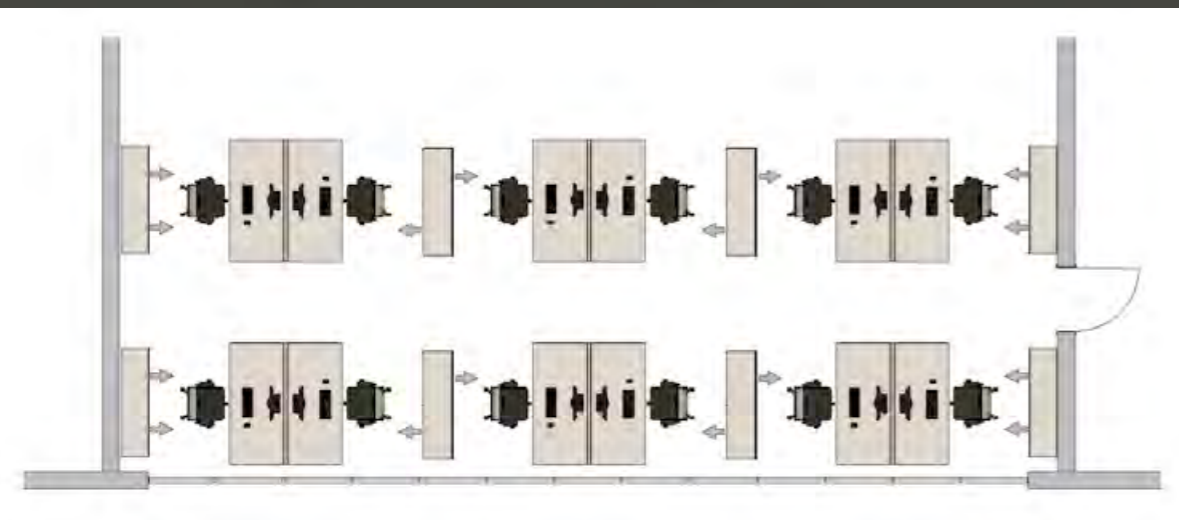

## SITAG Z-SCHIEBETÜRSCHRANK

SITAG z-sliding-door cabinet | Armoire à portes coulissantes en z de SITAG | Armadio con ante scorrevoli z SITAG

### VORTEILE UND NUTZEN

Advantages and benefits | Avantages et bénéfices | Utilità e vantaggi

#### | D | Z-SCHIEBETÜRSCHRANK

- hohe Flächen- und Kosteneffizienz
- mehr Ablagemöglichkeiten im persönlichem Erst-Zugriff
- durch die durchdachten Höhen kann der Deckel als Ablagefläche oder als Arbeitsflächen im Stehen genutzt werden
- Nischenmöglichkeit für Arbeitsplatz
- Einsatz bei verschiedenen Standardarbeitsplätzen möglich
- mehr Individualität und Privatsphäre am Arbeitsplatz möglich
- abschliessbar
- Türen in der Ausführung „Bulletin Board“ bepinntbar erhältlich.

#### | E | SITAG Z- SLIDING-DOOR CABINET

- great footprint and cost efficiency
- greater stowage possibilities for immediate personal access
- carefully designed heights that allow the cabinet tops to be used as stowage surfaces or as work areas while standing
- niche possibility for workplace
- application for various standard workplaces possible
- more individuality and privacy possible at workplace
- possibility of locking up
- doors available as pinboards, in “Bulletin Board” version.

#### | F | ARMOIRE À PORTES COULISSANTES EN Z

- encombrement réduit et efficacité en termes de coûts
- des rangements supplémentaires à portée de main
- grâce aux différentes hauteurs bien pensées, le dessus peut servir de dépose ou de surface de travail en position debout
- solution de niche pour le poste de travail
- utilisation possible pour différents postes de travail standards
- plus d'intimité et d'espace privatif au bureau
- verrouillable
- en version «Bulletin Board», disponibilité de portes d'affichage.

#### | I | ARMADIO CON ANTE SCORREVOLI Z

- grande efficienza in chiave di costi e superficie occupata
- Più possibilità di tenere materiali utili a portata di mano
- Grazie alle altezze ben concepite, il piano di chiusura può essere usato come superficie di appoggio o come piano di lavoro da usare in piedi
- Possibilità di creare una nicchia sul posto di lavoro preservando la propria intimità
- Possibilità di impiego in postazioni di lavoro standard di varie tipologie
- Possibilità di preservare più individualità e privacy sul posto di lavoro
- Chiudibile a chiave
- Ante disponibili in versione “bacheca” per appuntarci notizie e informazioni varie.

# SITAG Z-SCHIEBETÜRSCHRANK: DIE DETAILS

SITAG z-sliding-door cabinet: the details | Armoire à portes coulissantes en Z de SITAG: Les détails | Armadio con ante scorrevoli z SITAG: i dettagli

**| D | DURCH DIE 2-SEITIGE NUTZUNG** bei Z-Schiebetürschränken lässt sich die Fächeneffizienz erheblich steigern. Passend zu Tischtiefen von 80 bzw. 90 cm Tiefe gibt es die entsprechenden passenden Masse bei den Z-Schiebetürschränken. In der Höhe stehen zwei oder drei Ordnerhöhen zur Auswahl, die zusätzliche Ausrüstung mit Hängerahmenauszüge, Breitwandschubladen und Zusatztblaren ist möglich.

**| E | DOUBLE-SIDE USE** with Z-Sliding-Door Cabinets means significant enhancement of footprint efficiency. Matching desk depths of 80 or 90 cm, the corresponding fitting mass is available with the Z-Sliding-Door Cabinets. Two or three lever-binder shelves are available in height options. Additional equipping is possible with file hangers, wide-wall drawers, and additional shelves.

**| F | LES DEUX CÔTÉS UTILISABLES** des armoires à portes coulissantes en Z permettent d'optimiser considérablement les surfaces et les volumes. La profondeur des plans de travail de 80 et de 90 cm est appropriée aux dimensions respectives des armoires à portes coulissantes en Z. Les armoires proposent deux ou trois hauteurs de classeurs au choix, avec en supplément des cadres pour dossiers suspendus, des tiroirs extra larges et des tablettes supplémentaires.

**| I | GRAZIE ALL'UTILIZZO SU 2 LATI**, negli armadi con ante scorrevoli Z è possibile migliorare notevolmente l'efficienza per quanto riguarda la superficie occupata. Gli armadi con ante scorrevoli Z sono disponibili con dimensioni adatte a tavoli di una profondità di 80 o 90 cm. In altezza sono disponibili due o tre misure a scelta, a seconda dell'altezza dei raccoglitori. C'è inoltre anche la possibilità di una dotazione supplementare con telai estraibili per cartelle sospese, cassettoni e ripiani aggiuntivi.

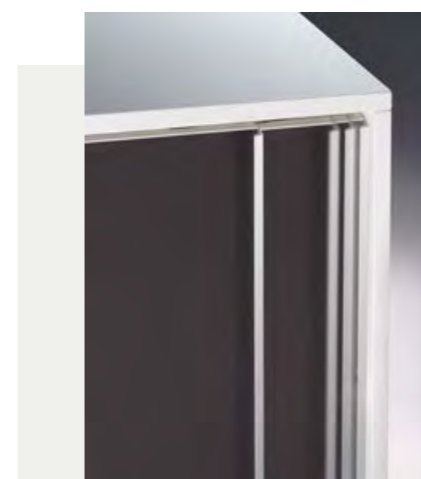
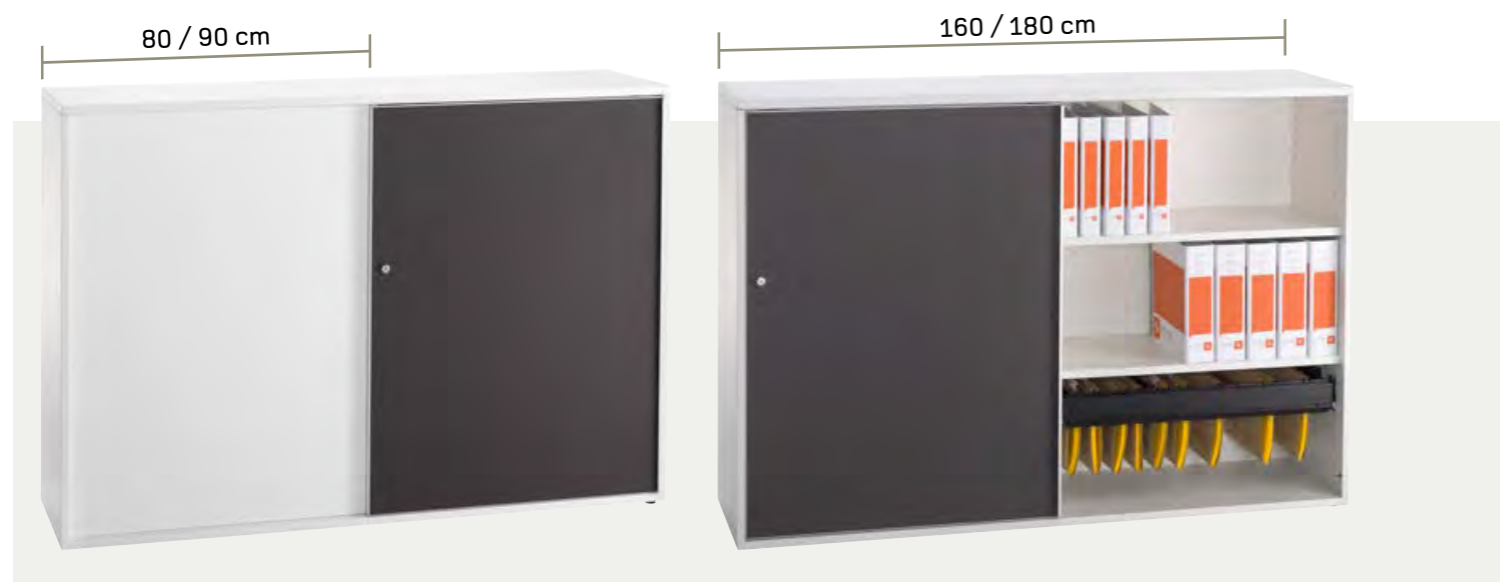

**| D |** Standard mit Einzugsdämpfer  
**| E |** Standard with drawer-slide damper  
**| F |** De série avec système d'amortissement  
**| I |** Standard con ammortizzatori di rientro

## Z-SCHIEBETÜRSCHRANK: IM ÜBERBLICK

Z-sliding-door cabinets: overview | Armoire à portes coulissantes en z: vue d'ensemble | Armadio con ante scorrevoli z: quadro d'insieme

**2 OH\***  
Höhe 74,4 cm

Z-Schiebetürenschränk  
Z-Sliding-Door Cabinets | Armoire à portes coulissantes en Z | Armadio con ante scorrevoli Z

**3 OH\***  
Höhe 115,5 cm

Z-Schiebetürenschränk  
Z-Sliding-Door Cabinets | Armoire à portes coulissantes en Z | Armadio con ante scorrevoli Z

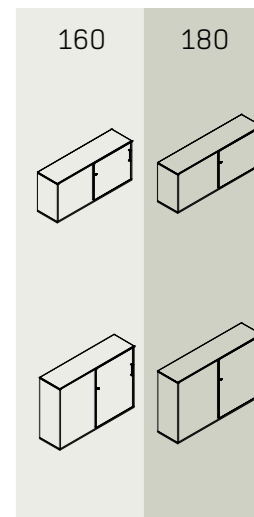

\*Ordnerhöhe = lever-binder height = hauteur de classeurs = altezza raccoglitore

# SITAG ORGATOWER

**| D | DAS MODERNE BÜRO IST** – entgegen aller Prognosen – weit davon entfernt papierlos zu werden. Daher ist es wichtig, jedem Mitarbeiter für die Ausübung seiner Aufgaben eine persönliche Ablage unmittelbar am Arbeitsplatz zuzugestehen. Der SITAG ORGATOWER, SITAG ORGATOWER LIGHT und SITAG ORGATOWER BASIC sind flächeneffiziente und zu allen Möbelprogrammen passende Lösungen.

**| E | THE MODERN OFFICE** – contrary to all predictions – is far from becoming paperless. This means that it is important to provide each employee with personal stowage possibilities, directly at his or her workplace. The SITAG ORGATOWER, SITAG ORGATOWER LIGHT and SITAG ORGATOWER BASIC are footprint-efficient solutions matching all office furniture collections.

**| F | CONTRAIREMENT À TOUTES PRÉVISIONS**, le bureau résolument moderne est loin de se passer de papier. C'est pourquoi, et pour la bonne exécution des tâches, il est essentiel d'équiper l'utilisateur d'un rangement personnel attendant à son poste de travail. Les tours de rangement SITAG ORGATOWER, SITAG ORGATOWER LIGHT et SITAG ORGATOWER BASIC sont des solutions efficaces au titre de l'occupation des surfaces; elles sont compatibles avec toutes les lignes de meubles.

**| I | L'UFFICIO MODERNO**, contrariamente a tutte le previsioni, è ben lontano dal poter rinunciare alla carta. È quindi importante dare ad ogni collaboratore una possibilità di appoggio direttamente sul posto di lavoro in modo da permettergli di svolgere al meglio la sua attività. La SITAG ORGATOWER, la SITAG ORGATOWER LIGHT e la SITAG ORGATOWER BASIC sono soluzioni efficienti in chiave di superficie occupata e adatta a tutti i programmi di mobili.



Der Innenkorpus ist immer in K310 weiss.  
Inside of enclosure is in K310 white for all models.  
Le corps intérieur pour tous les modèles est K310 blanc.  
L'elemento interno è in tutti i modelli in bianco K310.









## SITAG ORGATOWER LIGHT SITAG ORGATOWER BASIC

**| D | DER SITAG ORGATOWER LIGHT UND DER SITAG ORGATOWER BASIC** erweitern die Einsatzmöglichkeiten des „Platzspar-Prinzips“ von SITAG ORGATOWER um viele Varianten und finden ihren Platz überall dort, wo ein grösseres Modell keinen Platz findet oder nicht benötigt wird.

**| E | SITAG ORGATOWER LIGHT AND SITAG ORGATOWER BASIC** expand the possibilities of applying the Space-Saving Principle of SITAG ORGATOWER by adding many variants. These solutions are effectively used wherever there is no room for larger models, or where they are not needed.

**| F | LE SITAG ORGATOWER LIGHT ET LE SITAG ORGATOWER BASIC** étendent les possibilités d'application du « principe d'économie d'espace » de SITAG ORGATOWER par de nombreuses variantes et trouvent leur place partout où un modèle plus grand ne trouve aucune place ou n'est pas nécessaire.

**| I | LA SITAG ORGATOWER LIGHT E LA SITAG ORGATOWER BASIC** estendono le possibilità di un impiego salvaspazio di SITAG ORGATOWER a molte varianti e trovano posto ovunque non ci sia spazio per un modello di maggiori dimensioni o questo non sia necessario.





**| D | IN SOZIALER HINSICHT** wird das Büro immer mehr zum Ort der Begegnung. Trotzdem und gerade auch deswegen ist der Wunsch nach einer privaten und persönlichen Nische ungebrochen. Sie soll so ruhig wie möglich sein, trotzdem möchte man den Kontakt zu seinem Team. Der SITAG ORGATOWER stellt eine platzsparende Aufbewahrungslösung mittels Hightech-Mobiliar dar und ermöglicht dabei ein gewisses Mass von Privatsphäre am Arbeitsplatz.

**| E | FROM THE SOCIAL STANDPOINT**, the office is increasingly becoming a meeting place. Even so – and also precisely because of this development – the desire remains for a private and personal niche. It should be as quiet as possible, but should allow contact to team colleagues. The SITAG ORGATOWER represents a space-saving storage solution in the form of high-tech office furniture, and enables at the same time a certain degree of privacy at the workplace.

**| F | DU POINT DE VUE SOCIAL**, le bureau devient de plus en plus un lieu de rencontre et d'échange. Néanmoins, et peut-être justement pour cette raison, le besoin d'espace privatif et d'intimité persiste. Devant être aussi calme que possible, cet espace doit malgré tout favoriser le contact avec l'équipe. Le SITAG ORGATOWER est une solution de rangement économique high-tech offrant en sus un certain degré d'intimité au poste de travail.

**| I | DAL PUNTO DI VISTA SOCIALE** l'ufficio diventa sempre più un luogo di incontro. Nonostante, o forse proprio per questo, è più che mai attuale l'esigenza di una sfera privata e personale. Una nicchia che permetta più tranquillità possibile e al tempo stesso consenta di mantenere il contatto con i colleghi del team. La SITAG ORGATOWER costituisce una soluzione che, grazie a mobili ad alta tecnologia, permette di riporre materiali risparmiando spazio e preservando nei limiti del possibile una certa privacy sul posto di lavoro.



**| D | AUCH MIT HÖHENVERSTELLBAREN ARBEITSPLÄTZEN** lässt sich der SITAG ORGATOWER hervorragend kombinieren.

**| E | HEIGHT-ADJUSTABLE WORKPLACES** can also be effectively combined with the SITAG ORGATOWER.

**| F | LE SITAG ORGATOWER** se marie remarquablement bien aussi avec les plans de travail réglables en hauteur.

**| I | LA SITAG ORGATOWER** può essere abbinata eccellentemente anche a postazioni di lavoro ad altezza regolabile.

## SITAG ORGATOWER



## SITAG ORGATOWER LIGHT



## SITAG ORGATOWER BASIC

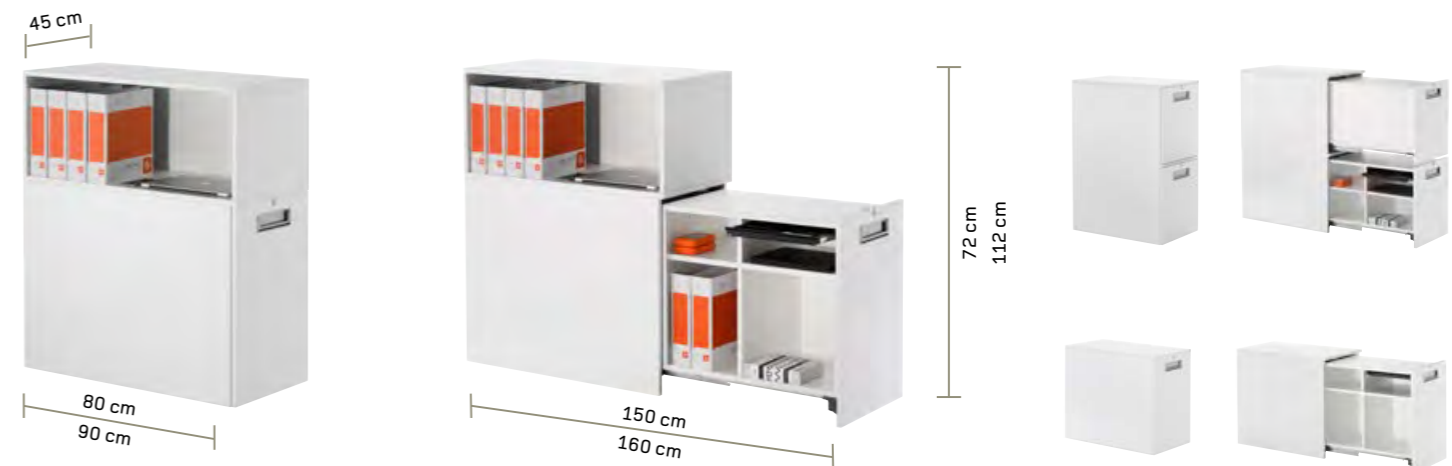

**| D | DER SITAG ORGATOWER** besitzt eine komplette Schubladeneinheit, der SITAG ORGATOWER LIGHT schliesst bündig und besitzt nur verstellbare Regalböden. Den SITAG ORGATOWER und ebenso die Light-Version gibt es in jeweils 3 Grössenversionen passend für unterschiedliche Tisch-Tiefen. Die SITAG ORGATOWER BASIC sind passend zu Tischtiefen von 80 cm und 90 cm erhältlich.

**| E | SITAG ORGATOWER** offers a complete drawer unit. SITAG ORGATOWER LIGHT closes flush with the unit and has only movable shelves. SITAG ORGATOWER as well as its Light version are each available in 3 size versions, to match various desk depths. SITAG ORGATOWER BASIC units fit desk depths of 80 and 90 cm.

**| F | LE SITAG ORGATOWER** comprend un bloc tiroirs, le SITAG ORGATOWER LIGHT ferme à fleur et dispose uniquement de rayons à hauteur variable. Le SITAG ORGATOWER, tout comme la version allégée, est disponible en 3 tailles adaptées chacune d'elles aux différentes profondeurs des tables. Le SITAG ORGATOWER BASIC est disponible pour des profondeurs de table de 80 cm et 90 cm.

**| I | LA SITAG ORGATOWER** può contare su un elemento a cassetti completo mentre la SITAG ORGATOWER LIGHT chiude a filo e dispone solo di ripiani regolabili. Sia la SITAG ORGATOWER che la sua versione Light sono disponibili rispettivamente in 3 misure abbinabili a tavoli di profondità diversa. Le SITAG ORGATOWER BASIC sono disponibili in formati adatte a tavoli di 80 cm e 90 cm di profondità.

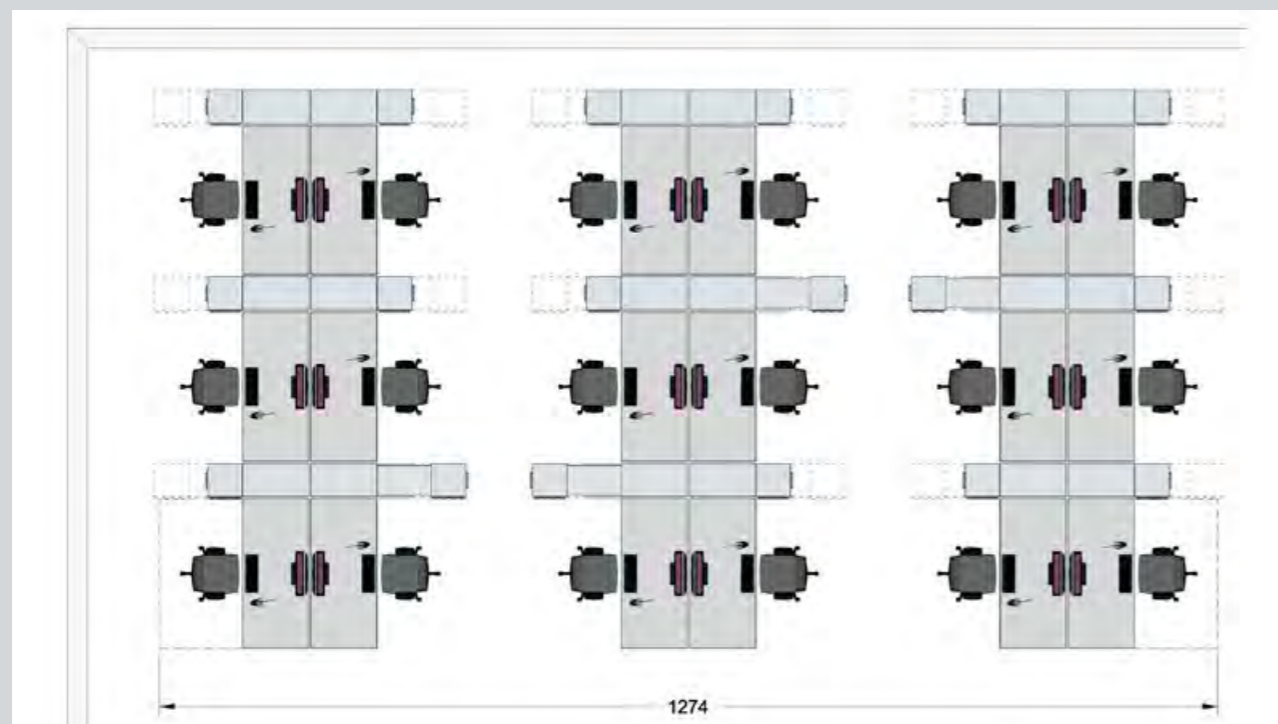
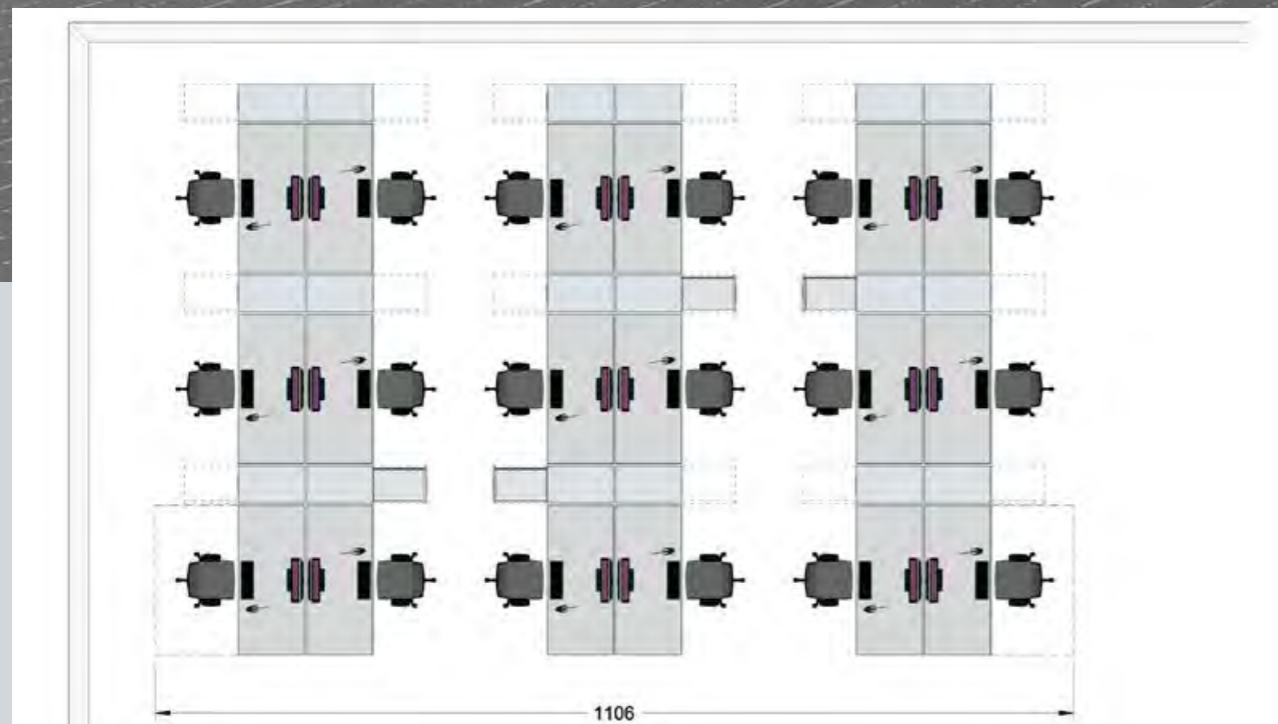

## SITAG ORGATOWER VORTEILE UND NUTZEN

Advantages and benefits | Avantages et bénéfices | Utilità e vantaggi

### | D | DER SITAG ORGATOWER ÜBERZEUGT DURCH

- hohe Flächeneffizienz
- mehr Ablagemöglichkeit im persönlichen Erst-Zugriff
- vielseitiger Korpus- oder Caddyersatz
- durch die Ablagefläche auf der obersten Ebene kann auch im Stehen gearbeitet werden. Sie ist ausgezogen als Arbeitsfläche geeignet, geschlossen dient sie als Schliessfach für den Laptop
- Nischenmöglichkeit für Arbeitsplatz
- Verbesserung der Akustikproblematik (ideal mit Akustikpanel zwischen den Arbeitsplätzen)
- Einsatz bei verschiedenen Standardarbeitsplätzen möglich, flexibel nutzbar durch Standardraster (Ordner, Büromaterial, private Tasche, etc.)
- mehr Individualität und Privatsphäre am Arbeitsplatz möglich
- abschliessbar mit Zentralverschluss
- mit Softeinzug
- schwebende Konstruktion (kein Abzeichnen von Rollen auf dem Boden).

### | E | THE SITAG ORGATOWER HAS PROVED CONVINCING BY:

- its great footprint efficiency
- greater stowage possibilities for immediate personal access
- highly versatile replacement for storage shells or pedestals
- the stowage surface at the top level, which allows working while standing. Pulled out, it is effective as work surface; closed, it serves as a locker for laptops, etc.
- provision of a niche atmosphere at the workplace
- enhancement of problematic acoustical situations (ideal with acoustic panel between the workplaces)
- effective for use with various standard workplace configurations; flexible use by standard spacing dimensions (for lever binders, office material, private handbags, etc.)
- greater individuality and privacy possible at the workplace
- security with central locking
- soft closing
- floating cantilever design (no marks on the flooring).

### | F | LE SITAG ORGATOWER S'IMPOSE PAR LES CARACTÉRISTIQUES SUIVANTES :

- optimisation importante de l'occupation des surfaces
- rangements supplémentaires à portée de main
- remplacement polyvalent des caissons ou caddies
- grâce à la surface de rangement qu'offre le plan supérieur, il est possible de travailler également en position debout. À l'état déployé, cette surface convient en tant que plan de travail, à l'état comprimé, elle sert de casier pour le portable
- solution de niche pour le poste de travail
- amélioration de l'acoustique (idéalement avec cloison acoustique entre les postes de travail)
- utilisation pour différents postes de travail standards, souplesse de mise en oeuvre grâce au rayonnage standard (classieurs, fournitures de bureau, sac personnel, etc.)
- davantage d'intimité et d'espace privatif au bureau
- verrouillage centralisé
- fermeture en douceur
- construction flottante (pas de traces de roulettes au sol).

### | I | LA SITAG ORGATOWER CONVINCe CON QUESTI ARGOMENTI:

- grande efficienza in chiave di costi e superficie occupata
- maggiori possibilità di appoggio e riponimento nell'area direttamente accessibile da seduti
- versatile alternativa a cassettoni e mobilio ingombrante
- grazie al piano di appoggio nel punto più alto, si ha la possibilità di lavorare anche in piedi; aperta, può fare da piano di lavoro mentre chiusa, serve da "cassetta di sicurezza" per il notebook
- possibilità di creare una nicchia sul posto di lavoro preservando la propria intimità
- miglioramento dell'acustica (ideale con pannello acustico tra le postazioni di lavoro)
- possibilità di impiego in postazioni di lavoro standard di varie tipologie
- utilizzabile con flessibilità grazie alla presenza di tacche standard per regolare gli spazi a seconda delle esigenze (per raccoglitori, materiale da ufficio, borsa privata ecc.)
- possibilità di preservare più individualità e privacy sul posto di lavoro
- con chiusura centralizzata
- struttura sospesa da terra (nessuna impronta di rotelle sul pavimento).

# SITAG ORGATOWER: DAS PLATZSPARPROGRAMM

The SITAG ORGATOWER: the space-saving program | SITAG ORGATOWER: la gamme à encombrement réduit | SITAG ORGATOWER: il programma salvaspazio

**| D |** SITAG ORGATOWER und der SITAG ORGATOWER LIGHT ist passend zu Tischiefen von 80, 90 und 100 cm lieferbar. SITAG ORGATOWER Basic gibt es passend zu Tischiefen von 80 und 90 cm.

**| E |** SITAG ORGATOWER and SITAG ORGATOWER LIGHT are available to fit desk depths of 80, 90 and 100 cm. SITAG ORGATOWER BASIC has models to fit desk depths of 80 and 90 cm

**| F |** LE SITAG ORGATOWER et le SITAG ORGATOWER LIGHT sont disponibles pour les plans de travail de 80, 90 et 100 cm de profondeur. Le SITAG ORGATOWER Basic est disponible pour les plans de travail de 80 et 90 cm de profondeur.

**| I |** La SITAG ORGATOWER e la SITAG ORGATOWER LIGHT sono disponibili in misure adatte a tavoli di 80, 90 e 100 cm di profondità. La SITAG ORGATOWER Basic è disponibile in misure adatte a tavoli di 80 e 90 cm di profondità.



# SITAG ORGATOWER: DETAILS

The SITAG ORGATOWER LIGHT: details | SITAG ORGATOWER LIGHT: les détails | SITAG ORGATOWER LIGHT: dettagli



**Bündiger Muschelgriff zum Auszug (SITAG ORGATOWER und SITAG ORGATOWER LIGHT)** | Flush recessed handles to pull out drawers (for SITAG ORGATOWER and SITAG ORGATOWER Light) | Poignée coquille affleurante pour le tiroir (SITAG ORGATOWER et SITAG ORGATOWER LIGHT) | Maniglia per aprire incassata a filo (SITAG ORGATOWER e SITAG ORGATOWER LIGHT)



**Die Ablagefläche für den Laptop ist im ausgezogenen Zustand als Arbeitsfläche geeignet, geschlossen dient sie als Schliessfach für den Laptop (SITAG ORGATOWER)** | The stowage surface for a laptop serves as a work surface when extended; closed, it serves as a locker for the laptop (SITAG ORGATOWER) | À l'état étiré, la dépose dédiée au portable se prête en tant que surface de travail, à l'état fermé, elle sert de casier de consignation du portable (SITAG ORGATOWER) | La superficie di appoggio per il notebook, ad ORGATOWER aperta, può essere usata come piano di lavoro mentre quando la "torre" è chiusa diventa la cassetta di sicurezza per il notebook (SITAG ORGATOWER)



**Rückseitiger verschlaufungsfreier Kabeldurchlass (SITAG ORGATOWER, optional)** | Cable access entry on the rear side that prevents cable tangles (for SITAG ORGATOWER, optional) | Passacàble évitant tout enchevêtrement à l'arrière (SITAG ORGATOWER, en option) | Passacavi su lato posteriore per evitare grovigli (opzione per SITAG ORGATOWER)



**Materialschalen bei SITAG ORGATOWER LIGHT (optional), Materialschieber bei ORGATOWER BASIC (serienmässig)** | Office-material storage trays for SITAG ORGATOWER LIGHT (optional); office-material slider compartment for ORGATOWER BASIC (standard) | Plumiers pour SITAG ORGATOWER LIGHT (en option), tiroirs plumiers pour ORGATOWER BASIC (standard) | Vaschette porta-oggetti per SITAG ORGATOWER LIGHT (opzione), cassetto per materiali vari per ORGATOWER BASIC (di serie)



**Zur Auswahl stehen 4 Griffarten (nur SITAG ORGATOWER): Muschelgriff, Stangengriff, C-Griff oder (wie hier abgebildet) der Lisengriff** | Four types of handles are available (only for SITAG ORGATOWER): flush recessed handles, T-bar handles, bowtype handles, or (as shown here) L-section pull handles | 4 types de poignées sont disponibles (seulement SITAG ORGATOWER): la poignée coquille, la poignée tige, la poignée étrier ou la poignée lésène (illustration) | Si può scegliere tra 4 tipi di maniglie (solo SITAG ORGATOWER): maniglia incassata, maniglia a sbarra, maniglia ad archetto oppure (come quella qui illustrata) presa a lesena

**Achtung! Innenkorpus ist bei allen Modellen in K310 weiss.** | Important: inside of enclosure is in K310 white for all models. | Attention! Le corps intérieur pour tous les modèles est K310 blanc. | Attenzione! L'elemento interno è in tutti i modelli in bianco K310.

**Die Regaleinheit schliesst zugeschoben mit dem Korpus ab (SITAG ORGATOWER LIGHT und SITAG ORGATOWER BASIC)** | When pushed inside, the shelf unit fits flush inside its enclosure (SITAG ORGATOWER LIGHT and SITAG ORGATOWER BASIC). | À l'état rentré, le bloc étagères ferme à fleur (SITAG ORGATOWER LIGHT et SITAG ORGATOWER BASIC) | L'elemento a scaffale una volta rientrato chiude a filo con l'elemento principale (SITAG ORGATOWER LIGHT e SITAG ORGATOWER BASIC)



# SITAG ORGATOWER: IM ÜBERBLICK

The SITAG ORGATOWER: overview | SITAG ORGATOWER: vue d'ensemble | SITAG ORGATOWER: dettagli

## SITAG ORGATOWER

links  
left | à gauche | sinistra

rechts  
right | à droite | destra

## SITAG ORGATOWER LIGHT

links  
left | à gauche | sinistra

rechts  
right | à droite | destra

## SITAG ORGATOWER BASIC

niedrig links  
low left | bas à gauche | Elemento basso a sinistra

niedrig rechts  
low right | bas à droite | Elemento basso a destra

## SITAG ORGATOWER BASIC

hoch links  
high left | haut à gauche | Elemento alto a sinistra

hoch rechts  
high right | haut à droite | Elemento alto a destra

## SITAG ORGATOWER BASIC

links mit Aufbau  
left with upper add-on | à gauche avec corps | Elemento applicato a sinistra

rechts mit Aufbau  
right with upper add-on | à droite avec corps | Elemento applicato a destra

## SITAG ORGATOWER BASIC

doppelseitig links  
double-side left left | double face à gauche | Elemento a doppio cassetto a sinistra

doppelseitig rechts  
double-side left right | double face à droite | Elemento a doppio cassetto a destra

für 80 Tiefe  
pour profondeur 80  
for 80-cm depth  
per profondità 80

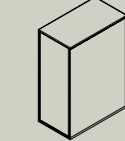
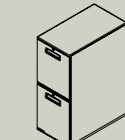
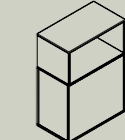
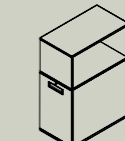
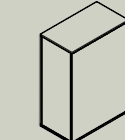
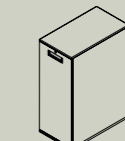
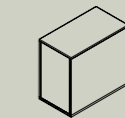
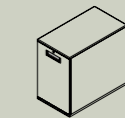
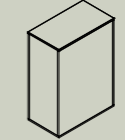
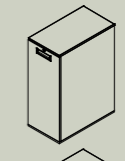
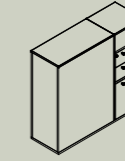
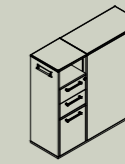

für 90 Tiefe  
pour profondeur 90  
for 90-cm depth  
per profondità 90

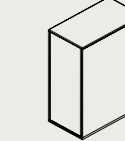
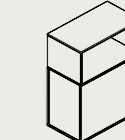
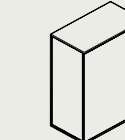
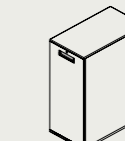
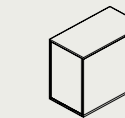
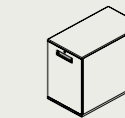
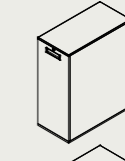
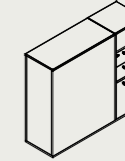
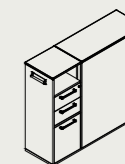

für 100 Tiefe  
pour profondeur 100  
for 100-cm depth  
per profondità 100

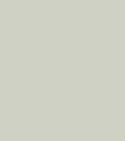
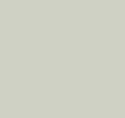
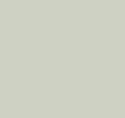
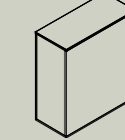
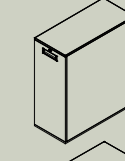
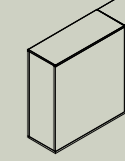
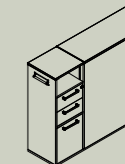

# SITAG MCS SCHRANKSYSTEM

The SITAG MCS cabinet system | Armoires systèmes SITAG MCS | Sistema per armadio SITAG MCS

Der modulare Aufbau des SITAG MCS Schranksystems sichert Ihnen die optimale Nutzung Ihrer Räume. Für welche Oberflächen, Materialien und Kombinationen Sie sich auch entscheiden – das Programm bietet Ihnen die richtige Lösung für die jeweilige Arbeitssituation und Ihre Bedürfnisse. Das SITAG MCS Schranksystem beweist, dass Ordnung und spannende Optik kein Widerspruch sein muss.



**| E | THE MODULAR DESIGN** of the SITAG MCS Cabinet System guarantees you the optimal use of your room space. For whatever surfaces, materials, and combinations you may decide – this collection offers you just the right solution for your individual work situation and for your requirements. The SITAG MCS Cabinet System proves that orderliness and exciting optics can coexist in harmony.

**| F | LA STRUCTURE MODULAIRE** des armoires systèmes MCS de SITAG est le gage de l'utilisation optimale des bureaux. Quels que soient la finition, les matériaux ou les compositions que vous choisirez, la gamme constituera la solution pertinente répondant parfaitement à tout cadre de travail et à tous les besoins. Les armoires systèmes MCS de Sitag prouvent que le besoin d'ordre et l'esthétique ne s'opposent pas forcément.

**| I | LA STRUTTURA MODULARE** del sistema per armadio MCS di SITAG vi garantisce un utilizzo ottimale dei vostri spazi. Qualsiasi finitura, materiale o abbinamento scegliate, il programma vi offrirà sempre la soluzione giusta per il caso applicativo in questione e per le vostre esigenze. Il sistema per armadio MCS SITAG dimostra che l'ordine e un'estetica accattivante non devono necessariamente essere in contraddizione.



# SITAG MCS SCHRANKSYSTEM

The SITAG MCS cabinet system | Armoires systèmes SITAG MCS | Sistema per armadio SITAG MCS



**| D | FLEXIBILITÄT MIT SYSTEM.** Das SITAG MCS SCHRANKSYSTEM (Modular Cabinet System) ist darauf ausgerichtet, in jeder Umgebung und für jede Vorstellung die optimale Lösung zu bieten. Das System besticht durch hochwertige Verarbeitung, funktionale Effizienz und klare, elegante Formgebung. Mit dem SITAG MCS Schranksystem gestalten Sie darüber Ihre Arbeitsumgebung flexibel nach Ihren individuellen Ansprüchen, ohne Kompromisse eingehen zu müssen. Alle Elemente werden als Kubus mit sichtbaren Seiten und Böden gezeigt. Die Fronten sind innenliegend und können auch kontrastierend zum Kubus gestaltet werden. Passend zu den Schrankelementen gibt es Trennwände und Verbindungselemente.

**| E | FLEXIBILITY WITH SYSTEM.** The SITAG MCS Cabinet System (MCS = Modular Cabinet System) was designed to offer the optimal solution for every office environment and for every furnishing concept. The system fascinates with its high-quality craftsmanship, functional efficiency, and clean, elegant design. With the SITAG MCS Cabinet System, you additionally design your working environment flexibly, in accordance with your individual expectations – without having to compromise. All elements are shown as cubes with visible sides and floors. The fronts lie to the inside and can also be provided in contrast to the cube. Dividing panels and connecting elements are available to match the cabinet elements.



**| F | QUAND SOUPLESSE RIME AVEC SYSTÈME.** Le système modulaire MCS de SITAG est conçu pour être la solution idéale en toute condition et pour toute configuration. Il séduit par sa finition exclusive, son efficacité fonctionnelle et ses formes épurées et raffinées. Avec les armoires système MCS de SITAG, configurez, sans compromis, votre espace bureau en toute souplesse et selon vos aspirations personnelles. Les parties latérales et le plancher des cubes modulables sont apparents. Articulées vers l'intérieur, les façades sont configurables également pour contraster avec le cube. Des cloisons et éléments de liaison assortis aux modules d'armoire sont disponibles.

**| I | FLESSIBILITÀ CON SISTEMA.** Il sistema per armadio MCS (Modular Cabinet System) di SITAG è concepito per offrire la soluzione ottimale in ogni ambiente e per ogni tipo di progetto. Esso si distingue per un'alta qualità di lavorazione, efficienza funzionale ed un linguaggio formale chiaro ed elegante. Grazie al sistema per armadio MCS SITAG potete arredare i vostri spazi di lavoro in modo flessibile, conformemente alle vostre esigenze personali, senza dover scendere a compromessi. Tutti gli elementi si presentano come una figura cubica con lati e fondi in vista. I frontali sono interni e possono essere realizzati anche in modo da risultare in contrasto con il cubo. In misure adatte agli elementi dell'armadio sono disponibili anche pareti divisorie ed elementi di collegamento.



# SITAG MCS SCHRANKSYSTEM

The SITAG MCS cabinet system | Armoires systèmes SITAG MCS | Sistema per armadio SITAG MCS



# SITAG MCS SCHRANKSYSTEM

The SITAG MCS cabinet system | Armoires systèmes SITAG MCS | Sistema per armadio SITAG MCS





# SITAG MCS SCHRANKSYSTEM

The SITAG MCS cabinet system | Armoires systèmes SITAG MCS | Sistema per armadio SITAG MCS



# SITAG MCS SCHRANKSYSTEM

The SITAG MCS cabinet system | Armoires systèmes SITAG MCS | Sistema per armadio SITAG MCS

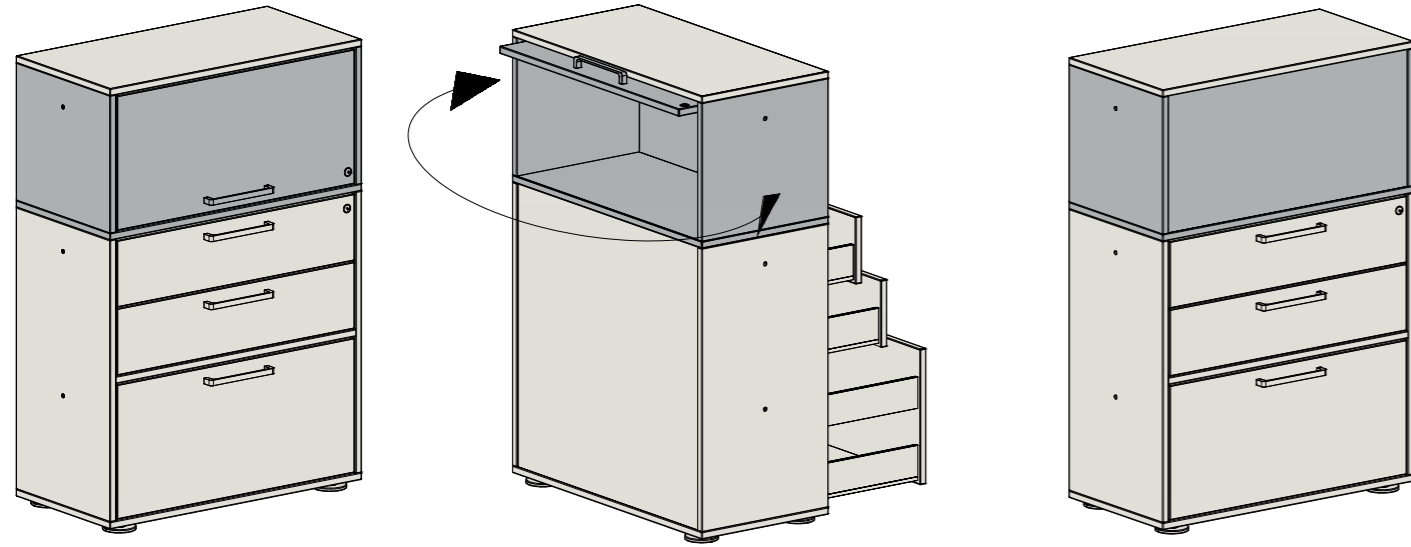

# SITAG MCS SCHRANKSYSTEM

The SITAG MCS cabinet system | Armoires systèmes SITAG MCS | Sistema per armadio SITAG MCS

## VORTEILE UND NUTZEN

Advantages and benefits | Avantages et bénéfices | Utilità e vantaggi

### | D | SITAG MCS SCHRANKSYSTEM

- durch verschiedene Grund-, Aufbau-, Beistell und Caddyelemente, teilweise kombinierbar mit Stellwänden, entsteht eine hohe Gestaltungsfreiheit
- das modulare Baukastensystem kann flexibel umgebaut und erweitert werden und ermöglicht die Anpassung an immer wieder neue Raumsituationen
- die Aufbauelemente können 180 Grad gedreht aufgesetzt werden
- alle Elemente und Schränke können mit oder ohne Verbindungsbohrungen bestellt werden, auch kombiniert links rechts oder mit Frontvarianten bestückt werden
- Zentralverschluss oder Einzelschliessung möglich, kann auch mit einer Kaba-Schliessung ausgerüstet werden
- alle Schubladen mit Vollauszug und Einzugsdämpfung, Klappen und Lifterfront mit integriertem Dämpfungssystem für minimale Lärm-entwicklung
- das SITAG MCS Schranksystem ist mit dem SITAG MCS Raumgliederungssystem kombinierbar und ermöglicht hohen Gestaltungsspielraum sowie verschiedene Raumsituationen
- die Stellwände sind in der Ausführung Stoff hoch schall- absorbierend
- Gehäuse und Fronten können in verschiedensten Materialien und Farben gewählt werden.

### | E | THE SITAG MCS CABINET SYSTEM

- various basic, attachment, side, and pedestal elements – often in combination with partition panels – offer great design leeway
- the modular system can be flexibly rearranged and expanded, and enables adapting to continuously new room situations
- the attachment elements can be emplaced with rotation by 180 degrees
- all elements and cabinets can be ordered with or without connecting holes – and can be combined to the left or right, or fitted with front-panel variants
- central or individual locking is possible, as well as equipping with a KABA lock system
- all drawers are with complete full drawer slide and with soft stop. Sprung handles and lifter fronts are with integrated damper systems for minimal noise
- the SITAG MCS Cabinet System can be combined with the SITAG MCS Room-Dividing Partition System, which enables great design leeway as well as a variety of room situations
- the partition panels, in their textile version, provide great noise absorption
- enclosures and fronts can be selected in a great variety of materials and colours.

### | F | ARMOIRES SYSTÈMES MCS DE SITAG

- combinables en partie avec des cloisons amovibles, les différents modules de base, les surmeubles, les modules d'appoint ainsi que les caddies laissent toute latitude à la configuration
- de conception modulaire, le système peut être transformé et complété en toute souplesse; il permet d'adapter les modules aux configurations sans cesse nouvelles
- les surmeubles peuvent être montés par rotation de 180°
- l'ensemble des modules et armoires est livrable avec ou sans alésages de raccordement, sous forme combinée à droite ou à gauche ou avec divers types de façades
- verrouillage centralisé ou individuel, peut également être équipé d'une serrure Kaba
- extension totale des tiroirs et système amortisseur, clapets et façades relevables dotés d'un système amortisseur intégré visant la réduction des nuisances sonores
- combinable avec le système de cloisons modulables MCS de SITAG, les armoires systèmes MCS de SITAG laissent carte blanche aux différentes configurations de l'espace.
- les cloisons amovibles exécutées en toile sont phono-absorbantes
- corps et façades se déclinent en une grande variété de matériaux et de coloris.

### | I | SISTEMA PER ARMADIO SITAG MCS

- grazie a diversi elementi di base, applicabili, accostabili e mobili, in parte abbinabili a pannelli e schermi protettivi, si può godere di una grande libertà realizzativa
- il sistema modulare può essere modificato e ampliato con flessibilità permettendo di adeguarsi a sempre nuove situazioni spaziali
- gli elementi applicabili possono essere applicati girandoli a 180°
- tutti gli elementi e armadi possono essere ordinati con o senza fori di collegamento o anche con fori sul lato destro e/o sinistro, gli elementi possono essere dotati di frontali di vari tipo
- possibilità di chiusura centralizzata o singola e anche di chiusura con serratura Kaba
- tutti i cassetti con possibilità di estrazione completa e ammortizzazione di rientro, sportelli e frontali ad apertura pneumatica con sistema di ammortizzazione integrato per ridurre al minimo il rumore
- il sistema per armadio MCS SITAG è abbinabile al sistema di suddivisione spazi MCS SITAG permettendo di sfruttare una grande libertà arredativa e di adeguarsi a diverse situazioni spaziali
- i pannelli e schermi protettivi, nella versione in stoffa, sono altamente fonoassorbenti
- il corpo esterno e i frontali possono essere scelti nei materiali e colori più svariati.

# KONFIGURATIONS-BEISPIEL

Configuration example | Exemple de configuration | Esempio di configurazione

### DECKEL

Top panel | Dessus | Piano di chiusura

### AUFSATZMODUL (2 OH)

Top add-on module (2 lever-binder shelves) | Module superposable (2 HC) | Modulo applicabile (2 altezze raccoglitore).

### GRUNDMODUL (3 OH)

Basic module | Module de base (3 HC) | Modulo di base (3 altezze raccoglitore).

### NIVELLIERGLEITER

Height-adjustment glider feet | Patins | Piedini di livellamento.

### Variante:

### SOCKEL

Option: Base | Variante: Pied support | Variante: base.

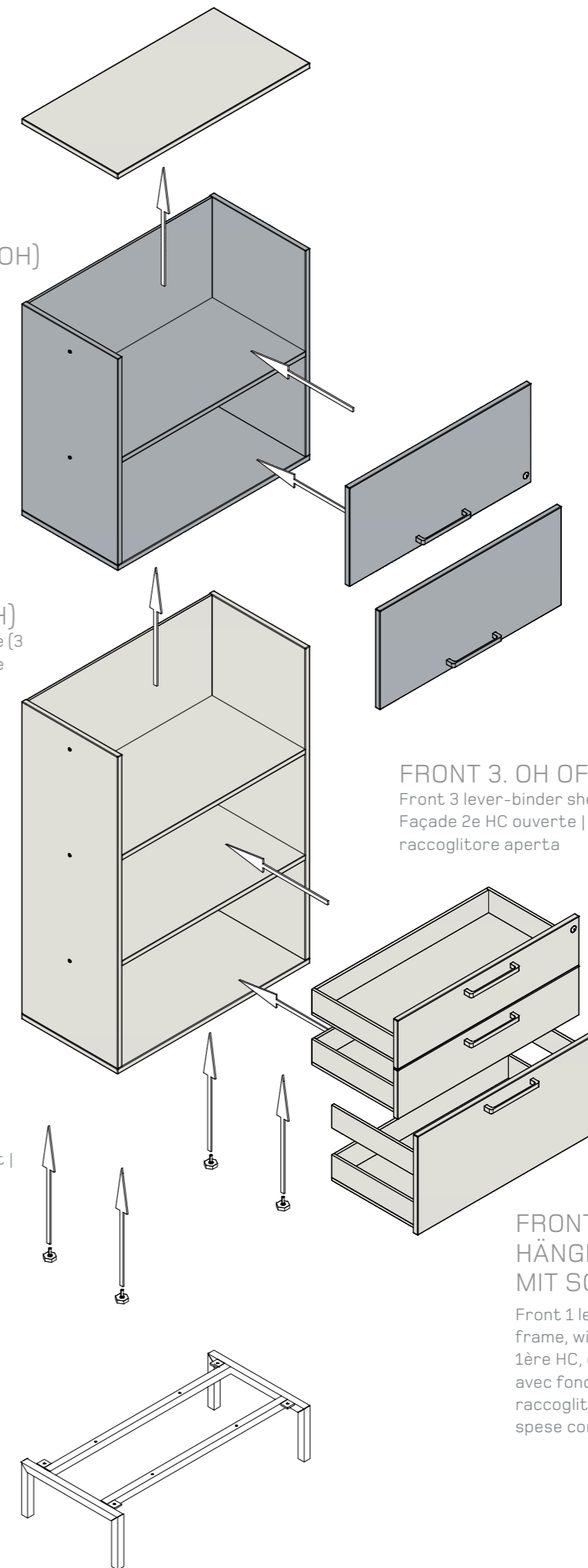

### FRONT 5. OH Z.B. LIFTKLAPPE

Front 5 lever-binder shelves e.G., Lift flap | Façade 5e HC p. ex. clapet relevable | Frontale 5 altezze raccoglitore, sportello ad apertura pneumatica.

### FRONT 4. OH Z.B. EINSCHUBKLAPPE

Front 4 lever-binder height e.G., slide flap | Façade 4e HC, p. ex. clapet d'insertion | Frontale 4 altezze raccoglitore ad es, sportello apribile a spinta.

### FRONT 3. OH OFFEN

Front 3 lever-binder shelves open | Façade 2e HC ouverte | Frontale 2 altezze raccoglitore aperta

### FRONT 2. OH 2 X A6 SCHUBLADEN

Front 2 lever-binder shelves 2 x A6 drawers | Façade 2e HC, 2 x tiroirs A6 | Frontale 2 altezze raccoglitore 2 cassetti A6.

### FRONT 1. OH HÄNGERAHMEN MIT SCHUBLADENBODEN

Front 1 lever-binder shelf, hanger frame, with drawer bottoms | Façade 1ère HC, cadre dossiers suspendus avec fond de tiroir | Frontale 1 altezza raccoglitore telaio per cartelle so-spese con fondo a cassetto.

# SITAG MCS SCHRANKSYSTEM: DIE DETAILS

SITAG MCS cabinet system: the details | Armoires systèmes MCS de SITAG: les détails | Sistema per armadio SITAG MCS: i dettagli



80 cm

120 cm

**SITAG MCS GRUNDMODULE** können individuell bestückt und erweitert werden und sind wahlweise mit Zentralver-schluss oder Einzelschliessung ausgestattet.  
**| E |** Basic MCS modules can be individually equipped and expanded, and can be fitted if desired with central or individual locking.  
**| F |** Les modules de base MCS de SITAG peuvent être équipés et complétés individuellement; le verrouillage est soit centralisé, soit individuel.  
**| I |** I moduli di base MCS SITAG possono essere equipaggiati e ampliati individualmente e sono dotati a scelta di una chiusura centralizzata o singola.



## SITAG MCS FLÜGELTÜRENSCHRÄNKE mit Stangenschloss.

**| E |** SITAG MCS hinged-door cabinets with rod lock.  
**| F |** Armoires à portes battantes MCS de SITAG avec fermeture à espagnolette.  
**| I |** Armadi con ante a battente SITAG MCS con serratura a cariglione.



## SITAG MCS ROLLLADENSCHRÄNKE

**| E |** SITAG MCS roller shutter cabinets  
**| F |** SITAG MCS armoires à rideaux  
**| I |** SITAG MCS armadi con serrandina

## AUFLEGESCHALE UND TRENNSCHIED

**| E |** Lay-on trays and compartment drawer  
**| F |** Plumier et élément de séparation  
**| I |** Vaschetta porta-oggetti e cassetto con divisorio interno



## SCHRÄGFÄCHER

**| E |** Slanted divider drawer  
**| F |** Casiers inclinés  
**| I |** Cassetto con scomparti obliqui



## HÄNGEREGISTERSCHUBLADE

**| E |** File-hanger drawer  
**| F |** Tiroir pour dossiers suspendus  
**| I |** Cassetto per cartelle sospese



## FRONTBESTÜCKUNGEN

**| E |** Front options  
**| F |** Façades  
**| I |** Dotazioni frontale

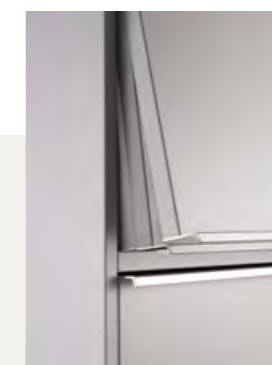

**| D |** Versenkbare Klappe mit Bremse. Ab 5 OH mit Lifterfront.  
**| E |** Recessed flap with stop. With lifter front from 5 binder shelves.  
**| F |** Clapet escamotable avec frein. Avec façade relevable à partir de 5 HC.  
**| I |** Sportello a scomparsa con freno. Da 5 altezze raccoglitore con frontale ad apertura pneumatica.



**| D |** Schublade Standard mit Einzugsdämpfer.  
**| E |** Standard drawer, with soft closure.  
**| F |** Tiroir de série avec système d'amortisseur.  
**| I |** Cassetto standard con ammortizzatori di rientro.

## GRIFFVARIANTEN

**| D |** Stangengriff  
**| E |** T-bar handle  
**| F |** Poignée tige  
**| I |** Maniglia a sbarra

**| E |** Handle options  
**| F |** Poignées  
**| I |** Varianti di maniglie

**| D |** Muschelgriff  
**| E |** Recessed handle  
**| F |** Poignée coquille  
**| I |** Maniglia incassata

**| D |** Lisenengriff  
**| E |** L-section pull handle  
**| F |** Poignée lésène  
**| I |** Presa a lesena

**| D |** C-Griff  
**| E |** Bow-type handle  
**| F |** Poignée carrée coudée  
**| I |** Maniglia ad archetto



## ORDNERSTÜTZE

**| E |** Binder supports  
**| F |** Serre-classeurs  
**| I |** Fermalibri per raccoglitori



# SITAG MCS SCHRANKSYSTEM: DIE DETAILS

SITAG MCS cabinet system: the details | Armoires systèmes MCS de SITAG: les détails | Sistema per armadio SITAG MCS: i dettagli



## SITAG MCS GRUNDMODULE

kombinierbar mit Schallaufsatzelement und Schallwänden.

| E | Basic SITAG MCS modules can be combined with sound-absorber attachments and partitions.

| F | Modules de base MCS de SITAG combinables avec structures et cloisons acoustiques.

| I | I moduli di base MCS SITAG sono abbinabili ad elemento applicabile fonoassorbente e pannelli acustici.



## WANGENAUFLAGEN

Mit den verschiedenen Wangenaufgaben lassen sich nicht nur reizvolle Blickfänge gestalten, sondern auch Theken und Besprechungs- und Ablagemöglichkeiten.

| E | Gable-table attachment units. The various gable-table attachment units are not only charming eyecatchers, but also offer countertops and discussion and stowage possibilities.

| F | Consoles d'appui. Très séduisantes, les différentes consoles d'appui peuvent servir de comptoir, de table haute d'entretien et de surface de dépose.

| I | Elementi ad appoggio su fianco. Usando vari elementi ad appoggio su fianco non solo si possono realizzare delle configurazioni esteticamente interessanti ma anche dei veri e propri banchi, piani di appoggio e tavoli alti da colloquio.



| D | Grenzenloser Gestaltungsspielraum mit den SITAG MCS Aufsatz- und Wandmodulen. Hoch schallabsorbierend (EMPA Bericht).

| E | Unlimited design leeway with SITAG MCS attachment and wall modules. Highly sound absorbent (EMPA Report).

| F | Les éléments de structure et les cloisons MCS de SITAG offrent des possibilités de configuration à l'infini. Haute absorption acoustique (rapport EMPA).

| I | Illimitata libertà di realizzazione grazie ai moduli a parete e applicabili MCS SITAG. Altamente fonoassorbente (rapporto EMPA).

| D | Elegante Verbindung des Deckels und der Aufbauelemente mit Clamex-Verbindern.

| E | Elegant connection of the top and the attachment elements, with CLAMEX connectors.

| F | Assemblage raffiné du dessus et de la structure moyennant des raccords Clamex.

| I | Collegamento elegante del piano di chiusura e degli elementi applicabili con connettori clamex.

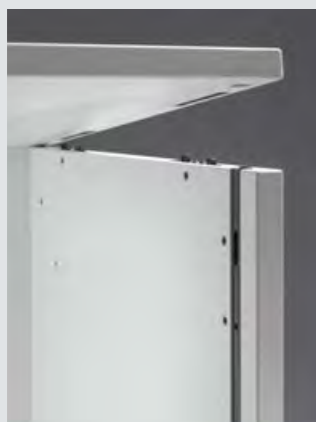

| D | Alle Schränke mit Wechselzylinder ausgestattet.

| E | All cabinets are fitted with interchangeable cylinder locks.

| F | Armoires toutes équipées de serrures à cylindre extractible.

| I | Tutti gli armadi sono dotati di cilindri intercambiabili.



| D | Tablarträger eingefräst und fixiert, trotzdem verstellbar für optimale Stabilität und Benutzerfreundlichkeit.

| E | Shelf supports counter-bored and permanently mounted – but can be adjusted for optimal stability and user convenience.

| F | Supports d'étagère fraisés et fixés, réglables en vue d'une stabilité et d'une convivialité optimales.

| I | Porta-ripiani fresato e fissato eppure regolabile per garantire ottimale stabilità e comodità d'uso.



| D | Alle Schränke mit Sichtrückwand für optimale Ästhetik, gleichgültig ob an der Wand oder frei im Raum. Bestückbar mit dünnen bepinnbaren Schallelementen.

| E | All cabinets are with attractive back panels for optimal aesthetics, whether facing the wall or open in a room.

| F | Armoires toutes dotées d'un panneau arrière de parement en vue d'une esthétique parfaite, quel que soit l'emplacement adossé au mur ou en îlot. Peuvent être dotées de minces feuilles acoustiques à épingler.

| I | Tutti gli armadi sono realizzati con pannello a vista rivestito per un'ottimale estetica, indipendentemente dal fatto che si tratti di versioni a parete o da installare nello spazio del locale. Possibilità di dotazione di elementi fonoassorbenti sottili e tali da potervi appuntare informazioni o simili.



# SITAG MCS SCHRANKSYSTEM: IM ÜBERBLICK

SITAG MCS cabinet system: overview | Armoires systèmes MCS de SITAG: vue d'ensemble | Sistema per armadio SITAG MCS: quadro d'insieme

## GRUNDELEMENTE

Basic elements | Modules de base | Elementi di base

## AUFBAUELEMENTE

Attachment elements | Modules surmeuble | Elementi applicabili

## REGALAUFBAUELEMENTE

Shelf attachment elements | Étagères surmeuble | Elementi a scaffale applicabili

## BEISTELLELEMENTE

Side elements | Modules d'appoint | Elementi accostabili

## SCHRANKAUFSATZELEMENT SCHALLSCHUTZ

Attached cabinet elements, sound absorption | Élément de structure armoire, protection acoustique | Elemento applicabile insonorizzante per armadio

## SCHRANKAUFSATZELEMENT GLAS

Attached cabinet elements, glass | Élément de structure armoire, vitré | Elemento applicabile in vetro per armadio

## FRONTEN

Fronts | Façades | Frontali

## SOCKEL

Bases | Pied support | Base

## 80

10H 1,50H 20H 2,50H 30H 40H 50H

20H 30H 40H 50H\*

0,50H 0,75OH 10H 20H 30H\*

20H 30H 20H 30H\*

20H 30H\*

## 120

10H 20H 2,5 OH 30H 40H\*

A6 A5 2xA6 HR HR-B KL

AB AS 2xA7 2xA6 HR HR-B KL LF

A6 2xA6 HR HR-B KL

## 120

10H\*

10H\*

\*OH=Ordnerhöhe = lever-binder height = hauteur de classeurs = altezza raccoglitori

## FRONTEN

Fronts | Façades | Frontali

## SOCKEL

Bases | Pied support | Base

## 60

## 80

## 120

## SCHRANKAUFSATZELEMENT SCHALLSCHUTZ

Attached cabinet elements, sound absorption | Élément de structure armoire, protection acoustique | Elemento applicabile insonorizzante per armadio

## SCHRANKAUFSATZELEMENT GLAS

Attached cabinet elements, glass | Élément de structure armoire, vitré | Elemento applicabile in vetro per armadio

## FRONTEN

Fronts | Façades | Frontali

## SOCKEL

Bases | Pied support | Base

## 80

## 120

## 60

## 80

## 120

## 80

## 120

## 60

## 80

## 120

## 80

## 120

## 60

## 80

## 120

## 80

## 120

## 60

## 80

## 120

## 80

## 120

## 60

## 80

## 120

## 80

## 120

## 60

## 80

## 120

## 80

## 120

## 60

## 80

## 120

## 80

## 120

## 60

## 80

## 120

## 80

## 120

## 60

## 80

## 120

## 80

## 120

## 60

## 80

## 120

## 80

## 120

## 60

## 80

## 120

## 80

## 120

## 60

## 80

## 120

## 80

## 120

## 60

## 80

## 120

## 80

## 120

## 60

## 80

## 120

## 80

## 120

## 60

## 80

## 120

## 80

## 120

## 60

## 80

## 120

## 80

## 120

## 60

## 80

## 120

## 80

## 120

## 60

## 80

## 120

## 80

## 120

## 60

## 80

## 120

## 80

## 120

## 60

## 80

## 120

## 80

## 120

## 60

## 80

## 120

## 80

## 120

## 60

## 80

## 120

## 80

## 120

## 60

## 80

## 120

## 80

## 120

## 60

## 80

## 120

## 80

## 120

## 60

## 80

## 120

## 80

## 120

## 60

## 80

## 120

## 80

## 120

## 60

## 80

## 120

## 80

## 120

## 60

## 80

## 120

## 80

## 120

## 60

## 80

## 120

## 80

## 120

## 60

## 80

## 120

## 80

## 120

## 60

## 80

## 120

## 80

## 120

## 60

## 80

## 120

## 80

## 120

## 60

## 80

## 120

## 80

## 120

## 60

## 80

## 120

## 80

## 120

## 60

## 80

## 120

## 80

## 120

## 60

## 80

## 120

## 80

## 120

## 60

## 80

## 120

## 80

## 120

## 60

## 80

## 120

## 80

## 120

## 60

## 80

## 120

## 80

## 120

## 60

## 80

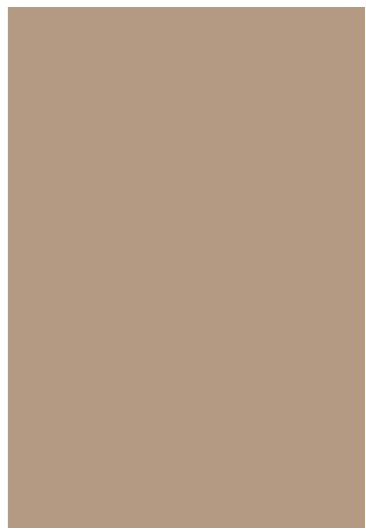
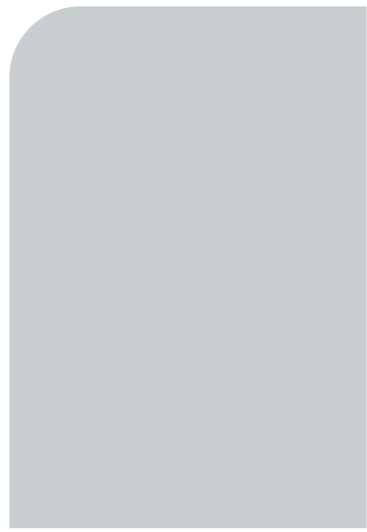
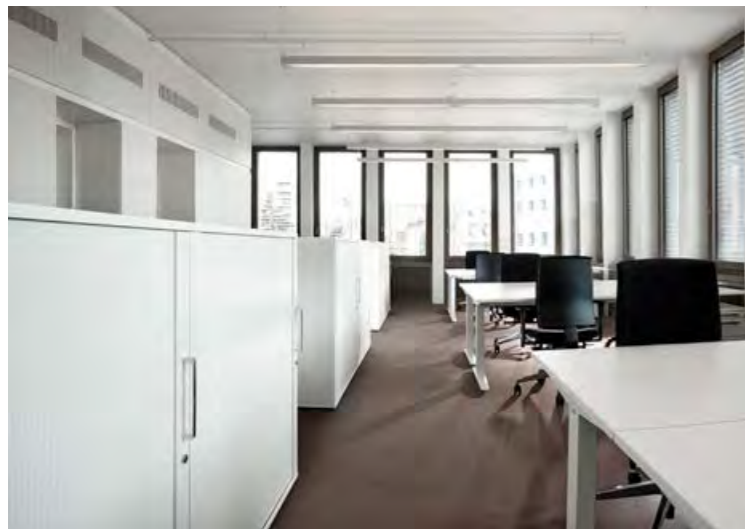

OFFICE  
LIFE  
STYLE

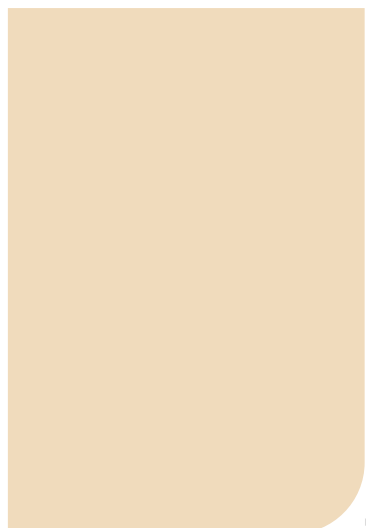
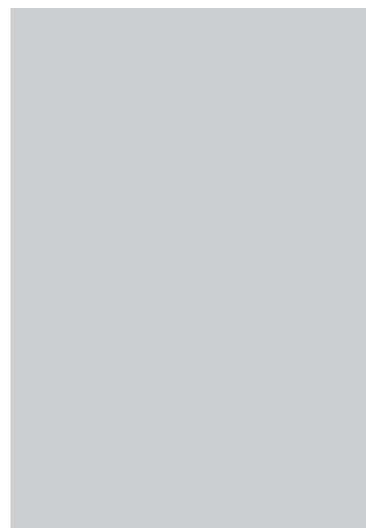

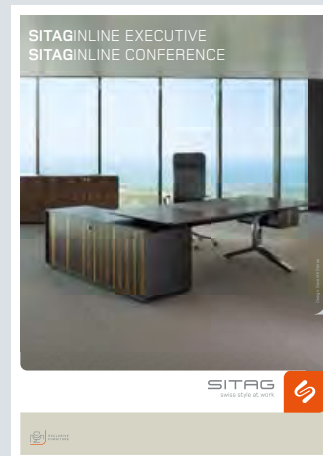
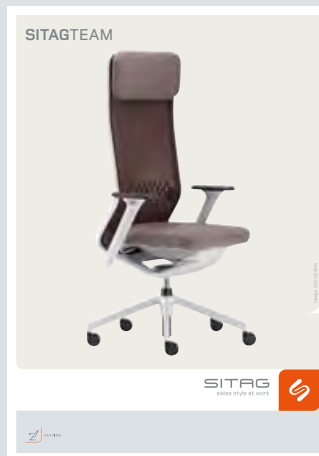
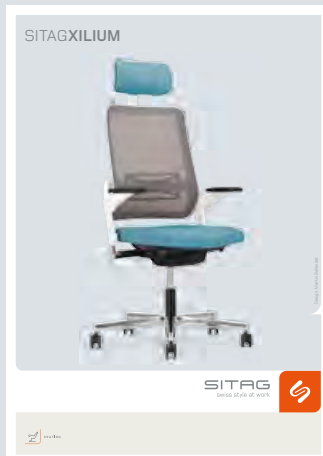

**| D |** Technische Änderungen, Druckfehler und Programmänderungen vorbehalten. Farbabweichungen von den Originalfarben sind drucktechnisch bedingt.  
**| E |** Subject to technical and programme alterations, printing errors, and other errors. Printed colours may vary from actual colours.  
**| F |** Sous réserve de modifications techniques, d'erreurs d'impression et d'altérations du programme. Les couleurs reproduites peuvent différer des couleurs originales.  
**| I |** Con riserva di modifiche tecniche, errori di stampa e cambiamenti di programma. Eventuali differenze di colore tra le immagini e i prodotti reali sono dovute alla stampa.

SITAG – a brand of the Nowy Styl Group  
[www.nowystylgroup.com](http://www.nowystylgroup.com)

**Nowy Styl Group**



#### SITAG Partners

##### Austria

Nowy Styl Group GmbH  
 Bahnhofstr. 24  
 6850 Dornbirn  
 T +43 55 72 290 26  
[austria@nowystylgroup.com](mailto:austria@nowystylgroup.com)  
[www.sitag.at](http://www.sitag.at)

Nowy Styl Group  
 Wolfsbach Nr. 48  
 4101 Feldkirchen / Donau  
 M +43 (0)664 11 28 503  
[austria@nowystylgroup.com](mailto:austria@nowystylgroup.com)

##### Belgium & Luxembourg

Buro & Design Center  
 Esplanade 1 PB 44  
 1020 Brussels, Belgium  
[belux@nowystylgroup.com](mailto:belux@nowystylgroup.com)

##### Czech Republic

Nowy Styl Group  
 Prague office Park 1  
 K Hájiřum 2 / 1233  
 155 00 Praha 5  
 T +420 296 357 190  
[p Praha@nowystylgroup.com](mailto:p Praha@nowystylgroup.com)

##### SITAG SA Nyon

Chemin du Joran 10  
 CH-1260 Nyon  
 T.+41(0) 22 361 47 27  
[info.nyon@sitag.ch](mailto:info.nyon@sitag.ch)

##### France

Nowy Styl Group  
 Showroom  
 32, boulevard Haussmann  
 75009 Paris  
 T +33 (0)1 43 57 71 61

Siège social  
 10, rue La Fontaine  
 38160 Saint Marcellin  
 T +33 (0)4 76 38 41 02  
[contact@nowystylgroup.fr](mailto:contact@nowystylgroup.fr)

##### Germany

SITAG AG  
 Vertriebsbüro Deutschland  
 Ringstr. 94  
 32427 Minden  
 T +49 571 388 609 30  
[info@sitag.de](mailto:info@sitag.de)  
[www.sitag.de](http://www.sitag.de)

Nowy Styl GmbH  
 Neumannstrasse 8  
 40235 Düsseldorf  
 T +49 211 583777-0  
[info@nowystylgroup.de](mailto:info@nowystylgroup.de)

Nowy Styl GmbH  
 Jubatus-Allee 1  
 92263 Ebermannsdorf  
 T +49 9438 949-0  
[info@nowystylgroup.de](mailto:info@nowystylgroup.de)

Nowy Styl GmbH  
 Voigtei 84  
 31595 Steyerberg  
 T +49 5769/7-0  
[info@nowystylgroup.de](mailto:info@nowystylgroup.de)

##### Hungary

Telmex - Nowy Styl Zrt.  
 Szentendre, Rózsa u. 23  
 2000 Hungary  
 T +36 26 503 100  
 M +36 20 326 0058  
[telmex@telmex.hu](mailto:telmex@telmex.hu)

##### Poland

SITAG Formy Siedzenia  
 Sp.z.o.o.  
 Łowecin, ul. Sarbinowska 11  
 62-020 Swarzedz  
 T +48 61 817 33 63  
[sitag@sitag.pl](mailto:sitag@sitag.pl)  
[www.sitag.pl](http://www.sitag.pl)

Export Department  
 Nowy Styl Group  
 Ul. Fabryczna 8  
 38-200 Jasło, Poland  
 T +48 13 437 6250  
[E: info@nowystylgroup.com](mailto:E: info@nowystylgroup.com)

##### The Netherlands

Nowy Styl Group  
 Basicweg 22  
 3821 BR Amersfoort  
 T +31 (0) 33 453 50 90  
[ned@nowystylgroup.com](mailto:ned@nowystylgroup.com)

##### Slovakia

Nowy Styl Group  
 Tovarenska 10  
 831 01 Bratislava  
 T +421 948 006 270  
[slovakia@nowystylgroup.com](mailto:slovakia@nowystylgroup.com)

##### United Kingdom

Nowy Styl Group  
 Unit 112  
 27-31 Clerkenwell Workshops  
 UK-Farringdon, London, EC1R OAT  
 T +44 20 3176 5230  
[info@nowystylgroup.co.uk](mailto:info@nowystylgroup.co.uk)

##### United Emirates

Nowy Styl Group  
 P.O. BOX 191289  
 United Arab Emirates, Dubai  
 T +971 507 596 159  
[middle.east@nowystylgroup.com](mailto:middle.east@nowystylgroup.com)

#### SITAG AG

Simon Frick-Str. 3  
 CH-9466 Senwald

T +41 (0) 81 758 18 18

[info@sitag.ch](mailto:info@sitag.ch)  
[www.sitag.ch](http://www.sitag.ch)

swiss workstyle

**SITAG**  
 swiss style at work

