

# Konferenzsysteme

*Conference systems*  
*Systèmes de conférence*

**hund**  
M Ö B E L W E R K E

**Aus Tradition Neues schaffen.**



# SIE ERWARTEN BESTEN SERVICE UND KNOW-HOW.

*You expect the best service and know-how.  
Vous attendez le meilleur service et du savoir-faire.*

Mit unseren Büroeinrichtungskonzepten wollen wir das moderne Arbeiten ergonomischer, funktioneller und stilvoller machen und Menschen für ihr Arbeitsumfeld begeistern. Wir haben es uns zur Aufgabe gemacht, intelligente Büromöbelsysteme und Inneneinrichtungslösungen für den Geschäftskundenbereich zu entwickeln und zu produzieren. Dabei ist es uns wichtig, unseren Kunden den optimalen Mehrwert durch industrielle Serienfertigung und die hauseigene Manufaktur zu bieten. Unser Ziel ist es, eine ideale Büroeinrichtung nach bedarfsorientiertem Planungsprinzip zu ermöglichen.

## OBERFLÄCHEN WIRKEN LASSEN.

Oberflächen spielen bei der Möbel- und Arbeitsraumgestaltung eine wichtige Rolle. Farben und Furniere dienen als Strukturierungs- und Stilelemente, die jedem Raum eine individuelle Note verleihen. Deshalb bieten wir unseren Kunden ein breites Spektrum an Farb- und Furniermöglichkeiten.



### FURNIERE

Wir lieben Furniere. Sie gehören zum Edelsten, was aus Holz hergestellt werden kann. Furniere sind ein Spiegel der Natur.

Bei Hund Möbelwerke wird das jahrtausendealte Veredelungsverfahren des Furnierens für die stilvolle Oberflächengestaltung von Konferenzanlagen, Einrichtungen für Geldinstitute und Empfangsanlagen eingesetzt. So wird aus jedem Möbel ein individuelles Unikat.

# KONFERENZSYSTEME

*Conference systems  
Systèmes de conférence*



## METACON

4 - 21

KOMMUNIKATION SUCHT KONZENTRATION.

*Communication is looking for concentration.*

*Communication a la recherche de concentration.*



## BESPRECHUNGSTISCHE

22 - 35

CONFERENCE TABLES / TABLES DE CONFÉRENCE

QUALITÄT UND STIL IN JEDER BESPRECHUNG.

*Quality and style at every meeting.*

*Qualité et style pour toute réunion.*

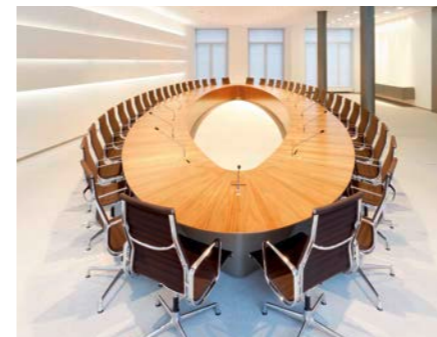

## MANUFAKTUR

36 - 41

MANUFACTURE / MANUFACTURE

DIE AUSNAHME BEDARF DER INDIVIDUALITÄT.

*Individuality demands exception.*

*L'exception requiert de l'individualité.*



## PRODUKTÜBERSICHT

*Product overview*

*Vue d'ensemble des produits*

42 - 44

# METACON

## KOMMUNIKATION SUCHT KONZENTRATION.

Communication is looking for concentration.

Communication a la recherche de concentration.

Kommunikation ist essentiell. Wer sich anderen mitteilen will, muss kommunizieren können. Im täglichen Geschäftsleben sind wichtige Gespräche, deutliche Worte und rasche Absprachen wesentlich. Zu optimalen Kommunikationsstrategien gehört ohne Zweifel ein Höchstmaß an Konzentration. Um sich der ungeteilten Aufmerksamkeit seines Gegenübers sicher zu sein, ist ein passendes Umfeld notwendig: Frei von unerwünschter Ablenkung und mit viel Platz für alle Unterlagen. Wenn ein Gesprächspartner genügend Bewegungsfreiheit hat, entsteht schnell eine positive Atmosphäre, die beste Arbeitsverhältnisse schafft. Die Voraussetzung ist hier jedoch, dass durch Flexibilität und leicht veränderbare Gegebenheiten reichlich Spielraum für alle » Konzentrationsfähigen und Kommunikationswilligen « entsteht.

Communication is essential. Those who want to share with others must be able to communicate. In daily business, important conversations, clear words and fast agreements are fundamental. Without doubt, a high level of concentration belongs to any optimal communication strategy. In order to be able to guarantee the undivided attention of others, a fitting environment is necessary: free from undesired distractions and lots of space for all of your documents. If a conversational partner has enough mobility, a positive atmosphere will quickly arise – which allows for the best working conditions possible. The requirement here, however, is that through flexibility and easily changeable conditions, there is enough space for all » those capable of concentrating and those willing to communicate «.

Communication est essentielle. Celui qui souhaite transmettre ses idées, doit maîtriser l'art de la communication. Dans le business quotidien, les entretiens importants, les mots clairs et des ententes rapides sont primordiaux. Un maximum de concentration est sans aucun doute nécessaire aux stratégies de communication optimisées. Afin de pouvoir compter sur toute l'attention de l'interlocuteur, il semble indispensable de disposer d'un environnement approprié : Sans distractions indésirables et avec plein d'espace pour tous les documents. Si l'interlocuteur dispose de suffisamment de liberté de mouvement, une atmosphère positive, indispensable aux bonnes conditions de travail, se crée rapidement. La condition préalable est toutefois que la flexibilité et les dispositions facilement modifiables permettent suffisamment de latitude pour tous ceux « souhaitant se concentrer et étant disposés à communiquer ».















Rack types and versions

Types de piètement et de versions



**Swing**

*Swing*

*Swing*



**TA Rechtecksäule**

Säule in Graphit.  
Ausleger in Chromoptik.

**TA rectangle column**

Column in graphite.  
Beam in chrome look.

**Colonne rectangulaire TA**

Colonne en graphite.  
Console d'aspect chromé.



**TA Rechtecksäule**

Säule und Ausleger in Graphit.

**TA rectangle column**

Column and beam in graphite.

**Colonne rectangulaire TA**

Colonne et console en graphite.



**TA Rundsäule**

Säule in Graphit.  
Ausleger in Chromoptik.

**TA round column**

Column in graphite.  
Beam in chrome look.

**Colonne arrondie TA**

Colonne en graphite.  
Console d'aspect chromé.



**TA Rundsäule**

Säule und Ausleger in Graphit.

**TA round column**

Column and beam in graphite.

**Colonne arrondie TA**

Colonne et console en graphite.



**TA Rundsäule**

Säule in Weißaluminium.  
Ausleger in Chromoptik.

**TA round column**

Column in white aluminium.  
Beam in chrome look.

**Colonne arrondie TA**

Colonne en aluminium blanc.  
Console d'aspect chromé.



**TA Rechtecksäule**

Säule in Weißaluminium.  
Ausleger in Chromoptik.

**TA rectangle column**

Column in white aluminium.  
Beam in chrome look.

**Colonne rectangulaire TA**

Colonne en aluminium blanc.  
Console d'aspect chromé.



**TA Rechtecksäule**

Säule und Ausleger  
in Weißaluminium.

**TA rectangle column**

Column and beam  
in white aluminium.

**Colonne rectangulaire TA**

Colonne et console  
en aluminium blanc.



**TA Rechtecksäule**

Als Abschlussfuß. Säule in Graphit.  
Ausleger in Chromoptik.

**TA rectangle column**

As a finish base. Column in graphite.  
Beam in chrome look.

**Colonne rectangulaire TA**

Comme pied de finition. Colonne en graphite.  
Console d'aspect chromé.



**TA Rundsäule**

Säule und Ausleger  
in Weißaluminium.

**TA round column**

Column and beam  
in white aluminium.

**Colonne arrondie TA**

Colonne et console  
en aluminium blanc.



**Gestellanbindung an Platte**

Mit Spezialverschluss.

**Frame connections on the panel**

With special closure.

**Raccordement piètement sur plateau**

Avec verrouillage spécial.



**Electric cover, long**

Equipped with 1 6-panel outlet, 3 x shock-proof plug and 3 x optional with media technology modules, here with a VGA-connection (analog) with mini-pin BCM-4K, 2 x RJ-45 CAT5E-connection for LAN connections, DVI-connection (digital) with mini-pin BCM-14A.

**E-Klappe, lang**

Bestückt mit 1 6-fach Steckdose, 3 x Schuko fest und 3 x frei wählbar mit Medientechnikmodulen, hier mit VGA-Anschluss (analog) mit Miniklinke BCM-4K, 2 x RJ-45 CAT5E-Anschluss für LAN-Verbindungen, DVI-Anschluss (digital) mit Miniklinke BCM-14A.

**E-Box, long**

Equipé de 1 prise de courant sextuple dont 3 x avec terre fixe et 3 x à choisir librement pour modules IT, ici avec prise VGA (analogique), prise mini-jack BCM-4K, 2 x prises RJ-45 CAT5E pour raccordements LAN, branchement DVI (numérique) avec mini-jack BCM-14A.



**E-Klappe, lang**

Geschlossen.

**Electric cover, long**

Closed.

**E-Box, long**

Fermé.



**Electric window**

Equipped with 2 3-panel outlets, each 1 x shock-proof plug and 2 x optional with media technology modules, here with a VGA connection (analog), USB 2.0 A-connection, 2 x RJ-45 CAT5E-connection for LAN connections, VGA-connection (analog) with mini-pin BCM-4K.

**E-Fenster**

Bestückt mit 2 3-fach Steckdosen, jeweils 1 x Schuko fest und 2 x frei wählbar mit Medientechnikmodulen, hier mit VGA-Anschluss (analog), USB 2.0 A-Anschluss, 2 x RJ-45 CAT5E-Anschluss für LAN-Verbindungen, VGA-Anschluss (analog) mit Miniklinke BCM-4K.

**E-fenêtre**

Equipé de 2 prises de courant triples, chacune 1 x avec terre et 2 x à choisir librement pour modules IT, ici avec prise VGA (analogique), prise USB 2.0A, 2 x prises RJ-45 CAT5E pour raccordements LAN, branchement VGA (analogique) avec prise mini-jack BCM-4K.

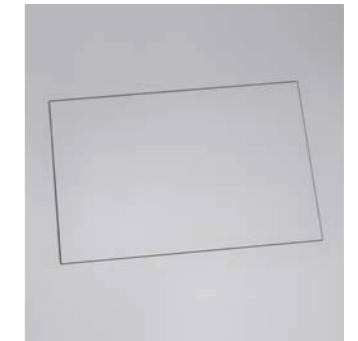

**E-Fenster**

Geschlossen.

**Electric window**

Closed.

**E-fenêtre**

Fermé.



**Electric cover, short**

Equipped with 1 3-panel outlet, 1 x shock-proof plug and 2 x optional with media technology modules, here with 2 x RJ-45 CAT5E-connection for LAN-connections, VGA-connection (analog) with mini-pin BCM-4K.

**E-Klappe, kurz**

Bestückt mit 1 3-fach Steckdose, 1 x Schuko fest und 2 x frei wählbar mit Medientechnikmodulen, hier 2 x RJ-45 CAT5E-Anschluss für LAN-Verbindungen, VGA-Anschluss (analog) mit Miniklinke BCM-4K.

**E-Box, court**

Equipé de 1 prise de courant triples, 1 x avec terre fixe et 2 x à choisir librement pour modules IT, ici avec deux prises RJ-45 CAT5E pour raccordements LAN, branchement VGA (analogique) avec prise mini-jack BCM-4K.



**E-Klappe, kurz**

Geschlossen.

**Electric cover, short**

Closed.

**E-Box, court**

Fermé.



## HDMI Anschluss

*HDMI connection*

*Raccordement HDMI*



## LAN-Anschluss

2 x RJ-45 CAT6.

*LAN connection*

*2 x RJ-45 CAT6.*

*Raccordement LAN*

*2 x RJ-45 CAT6.*



## USB 2.0 A-Anschluss

Einfach.

*USB 2.0 A-connection*

*Single type.*

*Raccordement USB 2.0 A*

*Simple.*



## Netbox

Bestückt mit 1 4-fach Steckdose,  
3 x Schuko fest und 2 x RJ-45  
CAT5E-Anschluss fest.

*Netbox*

*Version: anodized aluminium, equipped with 1 4-socket outlet,  
3 x Schuko fixed, 2 x RJ-45 CAT5E connection fixed.*

*Netbox*

*Finition : aluminium anodisé, équipé de 1 prise de courant  
quadruple, 3 x avec terre et 2 x prises RJ-45 CAT5E fixes.*



## Netbox

Geschlossen.

*Netbox,*

*Closed.*

*Netbox*

*Fermé.*



## Kabelbügel

Ausführung: Graphit.

*Cable clips*

*Version: graphite.*

*Étrier de câble*

*Finition : graphite.*



## VGA-Anschluss (analog)

15-polig.

*VGA connection (analog)*

*15-pin.*

*Raccordement VGA (analogique)*

*15 broches.*



## VGA-Anschluss (analog)

15-polig mit Miniklinke BCM-4K.

*VGA connection (analog)*

*15-pin with mini-pin BCM-4K.*

*Raccordement VGA (analogique)*

*15 broches avec mini-jack BCM-4K.*



## DVI-Anschluss (digital)

Mit Miniklinke BCM-14A.

*DVI connection (digital)*

*With mini-pin BCM-14A.*

*Raccordement VGA (numérique)*

*Avec mini-jack BCM-14A.*



## E-Rahmen

Geschlossen.

*Electric frame*

*Geschlossen.*

*E-Cadre*

*Geschlossen.*



## Einbau-Steckdose

1-fach mit RJ45- und USB oder HDMI-  
Anschluss. Ausführung: Alu eloxiert.

*Installed outlet*

*Single with RJ45 and USB or HDMI connection.*

*Version: anodized aluminium.*

*Prise encastrée*

*1 prise avec port RJ45 et port USB ou la HDMI.*

*Finition : aluminium anodisé.*

# BESPRECHUNGSTISCHE

CONFERENCE TABLES/TABLES DE CONFÉRENCE

## QUALITÄT UND STIL IN JEDER BESPRECHUNG.

Quality and style at every meeting.

Qualité et style pour toute réunion.

Grundlagen. Durchdachte Kommunikationsmittel sind die Basis für erfolgreiche Besprechungen und werden in nahezu allen Arbeitsbereichen benötigt. Die Anforderungen in Konferenz- und Besprechungssituationen steigen; die Abläufe werden immer weiter optimiert. Unsere Besprechungstische ermöglichen unkomplizierte Termine, effektive Gesprächsrunden oder ein kurzes Wort zwischen Kollegen. Der » workflow « wird nicht durch störende Nebensächlichkeiten wie starre Strukturen oder einem Mangel an Funktionalität beeinträchtigt. Hund Möbelwerke bietet Ihnen im wahrsten Sinn des Wortes eine optimale Grundlage. Perfekt flexibel für Ihren Alltag und Ihren Erfolg!

Basics. Well thought-out communication mediums are the basis for successful meetings and are needed in nearly all working areas. The demands in conference and meeting situations increase; procedures are always being optimized. Our conference tables allow for uncomplicated meetings and for both effective conversations and quick conversations with colleagues. The work-flow will not be affected by disruptive distractions like non-adjustable structures or a lack of functionality. Hund Möbelwerke literally offers you an optimal basis. Perfectly flexible for your everyday use and success!

Bases. Les moyens de communication bien pensés sont la base de réunions réussies ; ils sont indispensables dans quasiment tous les secteurs de travail. Les exigences des conférences et réunions augmentent, leur déroulement est de plus en plus optimisé. Nos tables de conférence permettent autant des réunions informelles que des négociations efficaces ou un rapide entretien entre collègues. Le « flux de travail » n'est pas freiné par des accessoires qui dérangent, comme les structures rigides ou un manque de fonctionnalité. Hund Möbelwerke vous offre véritablement une base optimisée. Parfaitement flexible pour votre quotidien et votre succès !













# FORMEN UND TECHNIK

Forms and technology  
Formes et technique



## Runder Tisch mit Säulenfußgestell

Rasterhöhenverstellbar 680–820 mm. Auch starr, 720 mm hoch erhältlich.

### Round table with column-shaped base

Adjustable height 680–820 mm. Also available fixed, 720 mm high.

### Table ronde avec pied colonne

Réglable en hauteur par paliers 680–820 mm.

Disponible également avec une hauteur fixe de 720 mm.



## Runder Tisch mit Säulenfußgestell

Komforthöhenverstellbar 720–1160 mm.

### Round table with column-shaped base

Comfort-adjustable height 720–1160 mm.

### Table ronde avec pied colonne

Réglable en hauteur pour confort 720–1160 mm.



## Runder Tisch auf Rollen

Komforthöhenverstellbar 720–1160 mm.

### Round table on wheels

Comfort-adjustable height 720–1160 mm.

### Table ronde sur roulettes

Réglable en hauteur pour confort 720–1160 mm.



## Rechtecktisch als Steh/Sitz

Elektromotorisch höhenverstellbar 650–1250 mm.

### Rectangular table as stand or sit

Electronically actuated height adjustable from 650–1250 mm.

### Table rectangulaire comme table debout/assis

Avec réglage d'hauteur motorisé de 650–1250 mm.



## Tonnenformtisch mit Säulenfußgestell

Rasterhöhenverstellbar 680–820 mm. Auch starr, 720 mm hoch erhältlich.

### Barrel form table with column-shaped base

Adjustable height 680–820 mm. Also available fixed, 720 mm high.

### Table en forme de tonneau avec pied colonne

Réglable en hauteur par paliers 680–820 mm.

Disponible également avec une hauteur fixe de 720 mm.



## Eckiger Tisch

Starr, 720 mm hoch. Auch Raster- und Komforthöhenverstellbar erhältlich.

### Square table

Fixed, 720 mm high. Also available with module and comfort height adjustment.

### Table carrée

Hauteur fixe de 720 mm. Disponible également en version avec un réglage facile

de la hauteur et avec une hauteur réglable par paliers.



## Vierfuß-Besprechungstisch

Starr, 720 mm hoch.

### Four leg conference table

Fixed, 720 mm high.

### Table de conférence à quatre pieds

Hauteur fixe de 720 mm.

# FORMEN UND TECHNIK

Forms and technology  
Formes et technique



**Schwenktisch**  
Starr, 740 mm hoch, mit Hebelverbinder.

**Rotary table**  
Fixed, 740 mm high, with lever link.

**Table rotative**  
Hauteur fixe de 740 mm, avec lien de levier.



**Schwenktisch**  
Zusammengeklappt, mit Hebelverbinder.

**Rotary table**  
Folded, with lever link.

**Table rotative**  
Rabattue, avec lien de levier.



**Klapptisch**  
Starr, 1070 mm hoch.

**Folding table**  
Fixed, 1070 mm high.

**Table rabattable**  
Hauteur fixe de 1070 mm.



**Klapptisch**  
Zusammengeklappt.

**Folding table**  
Folded.

**Table rabattable**  
Rabattue.

# BESPRECHUNGSTISCHE



**Hochbrücke**

**Viaduct**

**Console haute**



**Redner-/Beamerpult**  
Komforthöhenverstellbar 720–1160 mm. Auch starr und rasterhöhenverstellbar erhältlich.

**Speaker/operator desk**  
Comfort height adjustment 720–1160 mm. Also available as fixed and module height adjustable.

**Tabouret orateur/projecteur**  
Réglable facile de la hauteur entre 720–1160 mm. Disponible également en version à hauteur fixe et réglable en hauteur par paliers.



**Flipchart**

**Flip chart**

**Tableau à feuilles mobiles**

# MANUFAKTUR

MANUFACTURE/MANUFACTURE

## DIE AUSNAHME BEDARF DER INDIVIDUALITÄT.

Individuality demands exception.

L'exception requiert de l'individualité.

Maßarbeit. Wir bieten unseren Kunden individuelle Lösungen und maßgeschneiderte Konzepte an. Denn die meisten Arbeitsplätze benötigen keine Standardisierung, sondern Individualisierung! Jedes Unternehmen unterscheidet sich schließlich bezüglich Partner, Konkurrent oder Gegenüber, zum Beispiel im Bereich der Corporate Architecture. Hund Möbelwerke leistet hier ganze Arbeit in den Bereichen Entwicklung, Planung und Produktion. Unser wichtigstes Kriterium ist höchste Qualität bis ins kleinste Detail! Um ein zufriedenstellendes und optimales Ergebnis zu erhalten, sei es für eine komplizierte Aufgabe oder weitreichende Veränderungen, wird viel Aufmerksamkeit benötigt. Allerdings – in unserer Manufaktur finden wir keine Lösungen: Wir schaffen sie! Nur für Sie. Speziell für Ihre Details.

Precision work. We offer our customers individual solutions and custom-designed concepts. Most work spaces do not require standardization, but rather individualization! The demands for your company are clearly different than those from your partner, competitor or your counterpart – for example, in the corporate architecture field. Hund Möbelwerke does work in the areas of development, planning and production. Our most important criterion is the highest quality down to the smallest details! In order to receive a satisfactory and optimal resort, whether it is for a complicated task or for far-reaching changes, a lot of attention and care is required. However – we don't find any solutions in our company: We create them! Just for you. Specifically for your minutiae.

Travail sur mesure. Nous proposons à nos clients des solutions individuelles et des conceptions sur mesure. Car la majorité des postes de travail ne nécessite pas de standardisation, mais de la personnalisation ! Ce que l'on attend de votre entreprise est nettement différent de ce que l'on attend de votre partenaire, concurrent ou votre vis à vis, par exemple dans le domaine de l'architecture corporative. Hund Möbelwerke contribue ici au beau travail au niveau du développement, de la planification et de la production. Notre critère le plus important est la plus grande qualité jusqu'au plus petit détail ! Beaucoup d'attention est nécessaire pour obtenir un résultat satisfaisant et optimal que ce soit pour une tâche complexe ou des modifications importantes. Toutefois – nous ne trouvons pas les solutions dans notre manufactory : Nous les créons ! Pour vous, exclusivement. Spécialement en fonction de vos exigences.

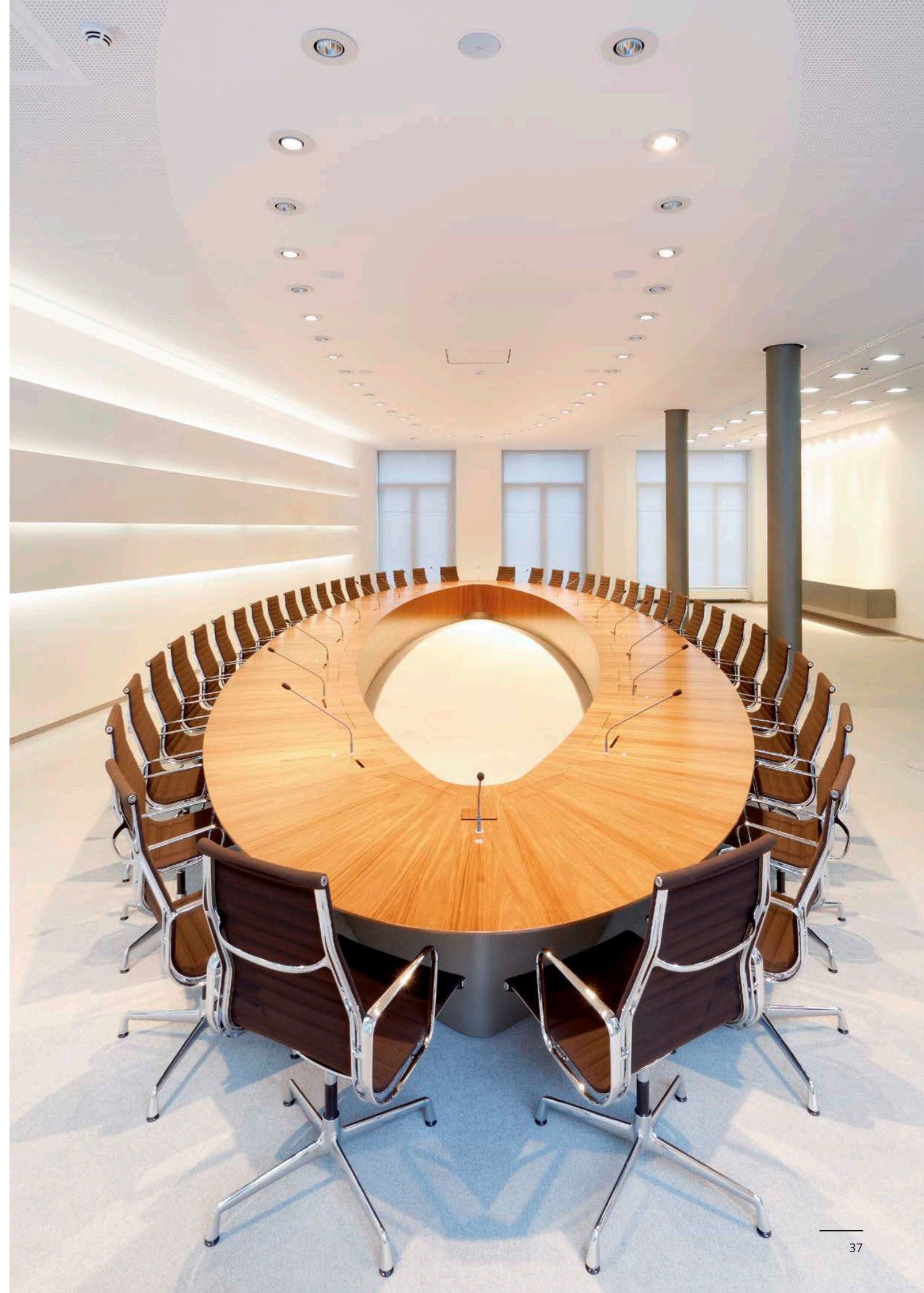





# GESTELLTYPEN

Rack types  
Piètements

# AUSFÜHRUNGEN

Versions  
Versions

# PLATTENFORMEN

Panel shapes  
Formes du plateau

Besprechungstische  
Conference tables  
Tables de conférence

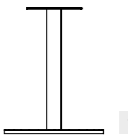
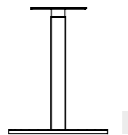
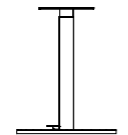
<p><b>Starr</b> Non-adjustable Rigide</p> <p>720/1120</p>  <p>1</p>	<p><b>Raster-Höhenverstellung</b> Adjustable height Hauteur réglable par paliers</p> <p>620 – 820</p>  <p>2</p>	<p><b>Schnell-Höhenverstellung</b> Quick-height adjustment Hauteur réglable rapide</p> <p>720 – 1160</p>  <p>3</p>
--	--	---





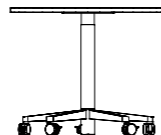

Graphit / Graphite / Graphite 1 2 3 4  
 Weißaluminium / White aluminum / Aluminium blanc 1 2 3 4  
 Barytweiß / Barite white / Blanc de baryte 1 2 3  
 Edelstahl / Stainless steel / Acier inoxydable 1

**Rollen**  
Wheels  
Roulettes

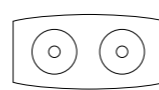

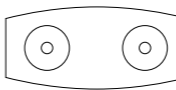
720 – 1160

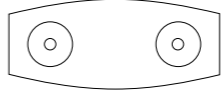

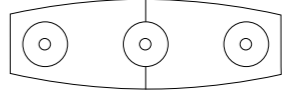
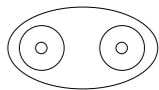
R 4

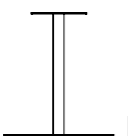
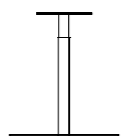
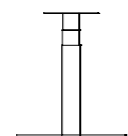
Ø 700  2000 x 800/1000 	Ø 800  2400 x 800/1100 	Ø 900  R 2800 x 800/1200 	Ø 1100  3600 x 800/1200 	2000 x 1100 
--	--	--	---	--

<p><b>Starr</b> Non-adjustable Rigide</p> <p>720/1120</p>  <p>1</p>	<p><b>Raster-Höhenverstellung</b> Adjustable height Hauteur réglable par paliers</p> <p>620 – 820</p>  <p>2</p>	<p><b>Elektromotorische Höhenverstellung</b> Electromotive height adjustment Hauteur réglable électromoteur</p> <p>570 – 1170</p>  <p>3</p>
---	---	---

Graphit / Graphite / Graphite 1 2 3  
 Weißaluminium / White aluminum / Aluminium blanc 1 2 3  
 Barytweiß / Barite white / Blanc de baryte 1 2

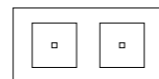
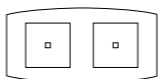
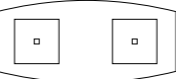
800 x 800  

2000 x 1000 E 	2000 x 800/1000 E 	2400 x 800/1100 E 	2800 x 800/1200 E 
---	---	---	---

E Nur für elektromotorische Höhenverstellung  
Only for Electromotive height adjustment  
Seulement pour Hauteur réglable électromoteur





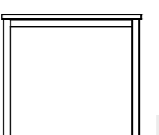



**Vierfuß**  
Four foot table  
Quatre pieds

720



1

Graphit / Graphite / Graphite 1  
 Weißaluminium / White aluminum / Aluminium blanc 1

700 x 700 	800 x 800 	1200 x 800 	1400 x 700 	1600 x 800 	2000 x 1000 	1400 x 800 	2000 x 800/1000 
--	--	---	---	---	--	---	--

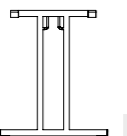
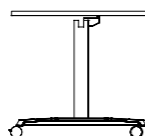
<p><b>Klapptisch</b> Folding table Table pliable</p> <p>750</p>  <p>1</p>	<p><b>Schwenktisch</b> Rotary table Table rotative</p> <p>745</p>  <p>2</p>
--	--







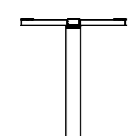
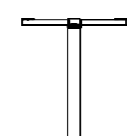
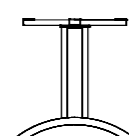







Graphit / Graphite / Graphite 1 2  
 Weißaluminium / White aluminum / Aluminium blanc 1 2  
 Chrom / Chrome / Chrome 1  
 Fußausleger Alu poliert / 2  
 Leg arm Alu polished / Base du pied Alu poli  
 + Säule Graphit 2  
 + Column Graphite / + Colonne Graphite  
 + Säule Weißaluminium 2  
 + Column White Aluminium / + Colonne Aluminium blanc

1400 x 700 	1600 x 800 
---	---

Metacon

<p><b>TA Rechtecksäule</b> TA rectangle column Colonne rectangulaire TA</p> <p>720</p>  <p>1</p>	<p><b>TA Rundsäule</b> TA round column Colonne arrondie TA</p> <p>720</p>  <p>2</p>	<p><b>Swing</b> Swing Swing</p> <p>720</p>  <p>3</p>
---	--	---

Graphit / Graphite / Graphite 1 2  
 Weißaluminium / White aluminum / Aluminium blanc 1 2  
 Chrom / Chrome / Chrome 3  
 Fußausleger Alu poliert / 1 2  
 Leg arm Alu polished / Base du pied Alu poli  
 + Säule Graphit 1 2  
 + Column Graphite / + Colonne Graphite  
 + Säule Weißaluminium 1 2  
 + Column White Aluminium / + Colonne Aluminium blanc

800 x 800 	1200 x 800 	1400 x 800 	1600 x 800 	1800 x 800 	2000 x 800 	1600 x 800 	850 x 850 
2000 x 800/1000 	2400 x 1100/800 	1378 x 1151 	1400 x 1200 	1400 x 1200/800 	1800 x 1200/800 	1500 x 1200 	

# OBERFLÄCHEN

Surfaces  
Surfaces

Natursand	Natural sand/Sable naturel
Lichtgrau	Light-grey/Gris clair
Weiß	White/Blanc
Decor Ahorn	Maple laminate/Décor érable
Decor Havanna	Havanna laminate/Décor havanna
Decor Wildbuche	Wild beech laminate/Décor hêtre sauvage
Decor Eiche hell	Light-coloured oak laminate/Décor chêne clair
Decor Wenge hell	Light-coloured Wenge laminate/Décor bois wengé clair
Furnier Buche natur	Veneer beech natural/Placage hêtre naturel
Furnier Ahorn	Veneer maple/Placage érable
Furnier Eiche gekalkt	Veneer oak whitewashed/Placage chêne chaulé
Furnier Nussbaum	Veneer walnut/Placage noyer
Furnier Olivensche	Veneer olive-ash/Placage frêne olive
Furnier Teak	Veneer teak/Placage teck
Furnier Räuchereiche	Veneer smoked Oak/Placage chêne fumé

Nicht für tonnen- und ellipsenförmige Tische, nicht für Tische mit elektromotrischer Höhenverstellung.

Not for barrel and elliptical tables, not for tables with electromotive height adjustment.

Les finitions suivantes ne sont pas compatibles avec plateaux plus long que 2000 mm.

Weiß/Weiß	White/White/Blanc/Blanc
Weiß/Graphit	White/Graphite/Blanc/Graphite



**DIGITALE FARBCOLLAGE**  
DIGITAL COLOUR COLLAGE  
COLLAGE DE COULEUR DIGITAL

Kombinieren Sie Farben und Oberflächen auf unserer Website.

Combine colours and surfaces on our website.

Combiner les couleurs et les surfaces sur notre site Web.



# SIE ERWARTEN BESTEN SERVICE UND KNOW-HOW.

You expect the best service and know-how.

Vous attendez le meilleur service et du savoir-faire.



**AKUSTIK**  
ACOUSTICS  
ACOUSTIQUE

Individualschulung zum Thema  
Raumakustik und OFML Akustik Plug In.

Individual training on the subject of space  
acoustics and OFML Acoustics Plug In.

Formation individuelle sur le sujet de l'acoustique  
spatiale et OFML Acoustics Plug In.



**PLANUNGSDATEN**  
PLANNING DATA  
DONNÉES DE PLANIFICATION

Hochwertige 3D-Darstellung, Planungs-  
logik und vollständige Produktlogik.

High-quality 3D illustration, planning  
logic and complete product logic.

Représentation réaliste en 3D, logique de  
planification et logique complète du produit.



**FARBEN & OBERFLÄCHEN**  
COLOURS AND SURFACES  
COULEURS ET SURFACES

Digitale Farbcollage und Farbwelt  
zur Unterstützung bei der Farbauswahl.

Digital colour collage and world of colour  
assisting in the colour selection.

Collage de couleur digital et monde de couleurs  
pour aider dans la sélection des couleurs.



**SEMINARE & SCHULUNGEN**  
SEMINARS AND TRAINING  
SÉMINAIRES ET FORMATION

Jährliche Seminar- und Schulungs-  
angebote für unsere Fachhandelspartner.

Annual seminars and courses  
for our retail partners.

Séminaires annuels pour  
nos partenaires commerciaux.

**hund**  
M Ö B E L W E R K E



**B2B ONLINE SHOP**  
B2B ONLINE SHOP  
BOUTIQUE EN LIGNE POUR B2B

Individualisierter Internetshop für  
den Fachhandelspartner.

A customized Internet shop  
for the specialized retail partner.

Boutique internet individualisée pour  
le partenaire commercial.



**PLANUNGSPRINZIP**  
PLANNING PRINCIPLE  
PRINCIPE D'AMÉNAGEMENT

Digitaler Leitfaden für die perfekte  
Büroraumgestaltung.

Digital guideline  
for the perfect office design.

Guide numérique  
pour la parfaite conception de l'espace du bureau.



**SCHNELLIEFERSORTIMENT**  
FAST-DELIVERY-PRODUCT RANGE  
ASSORTIMENT LIVRAISON EXPRESS

Lieferung von Starkläufermodellen  
innerhalb von 11 Arbeitstagen.

Delivery of top-seller models  
within 11 work days.

Livraison de modèles courants  
dans les 11 jours ouvrables.



**GEPR. BÜROEINRICHTER**  
CERTIFIED INTERIOR OFFICE DESIGNER  
SPÉCIALISTE EN AGENCEMENT DE BUREAUX

Konzeption und Realisierung von Büro-  
planungen durch qualifizierte Experten.

Conception and implementation  
of office designing through qualified experts.

Conception et réalisation de planifications de  
bureaux par expert architecte d'intérieur.

**Aus Tradition Neues schaffen.**

**Hund Möbelwerke**

**GmbH & Co KG**

**Werk Biberach**

Am Güterbahnhof 11

77781 Biberach/Baden

GERMANY

Telefon +49.7835.635-0

Telefax +49.7835.635-119

info@hund-moebel.de

**Hund Möbelwerke**

**GmbH & Co KG**

**Informationszentrum**

Schwanhäuser Straße 2

97528 Sulzdorf a. d. L.

GERMANY

Telefon +49.9763.9192-0

Telefax +49.9763.9192-19

info@hund-moebel.de

Ihr kompetenter Partner vor Ort

*Your competent partner in your vicinity*

*Votre partenaire compétent sur site*