

# basic<sup>flow</sup>

STAURAUM IN BEWEGUNG

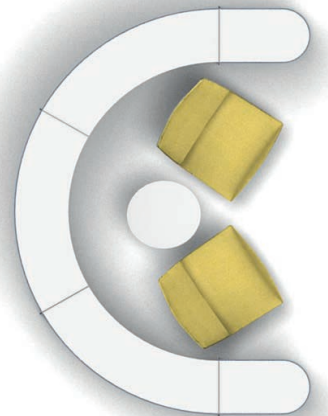

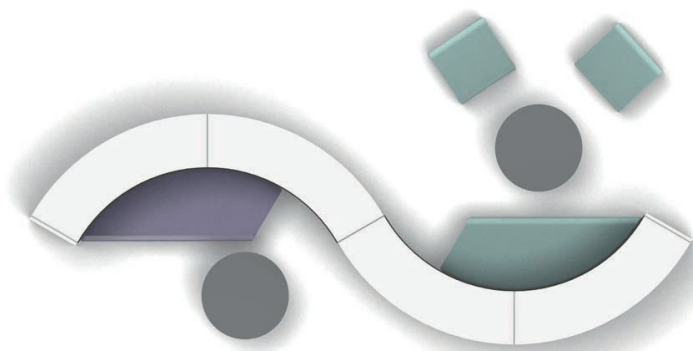

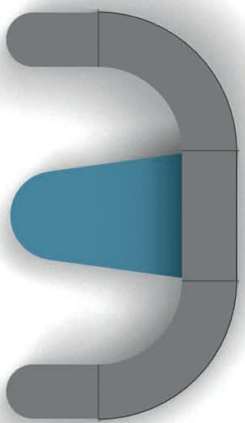

basic<sup>low</sup> ist ein Regalsystem, das als Raumteiler Räume strukturiert, Stauraummöglichkeiten schafft und zugleich visuelle und akustische Abschirmung bietet.

basic<sup>low</sup> is a shelf system which can be used as a room divider to create spaces and storage areas and that also serves as a visual and acoustic screening element.



## FLOW - WORKS

Die Arbeitswelt ist in Bewegung und findet zukünftig überall statt. Ob wir mit der Bahn fahren, in der Hotellobby frühstücken oder im Park relaxen, überall begegnen wir Menschen, die ihren persönlichen Ort zum Arbeitsplatz gemacht haben.

Dennoch treffen wir alle in den Büros wieder. Hier findet der Wissensaustausch statt. Das Büro wird zum Ort der Begegnung, soziales „Auffanglager“, Ort für Ideen und Kreativität. Hier wird Unternehmenskultur gelebt und eine sichere Basis geschaffen für die Entwicklung gemeinsamer Ziele.

Deshalb sieht werner works die Bürogestaltung der Zukunft als zentrales Instrument, um kreative und innovative Menschen anzuziehen und zu halten. Vor diesem Hintergrund hat werner works basic<sup>flow</sup> entwickelt: ein raumstrukturierendes Regalsystem, das bewegliche Räume für moderne Büroarbeit schafft.

Our working environments are in flux and today we can work virtually anywhere. In trains, breakfasting in the hotel lobby, relaxing in a park - everywhere we see people who have turned their personal space into their own workplaces.

However, we still all meet in our offices. This is where information flows. The office is becoming a meeting place, a social hub, a place for ideas and creativity. This is where the corporate culture is experienced and practised, creating a sound basis for the development of common goals.

For this reason werner works regards the office design of the future as a central tool to attract and keep creative and innovative people. With this in mind, werner works developed basic<sup>flow</sup> - a space-structuring shelf system that creates variable areas for contemporary office work.



05 - 12	FLOW - SPACE
13 - 18	FLOW - SIT
19 - 22	FLOW - FOCUS
23 - 28	FLOW - COUNTER
29	SORTIMENT
30	FARBEN UND MATERIALIEN

# FLOW - SPACE



Der Kern des Systems ist das einzigartige Jalousieprinzip. Äußerlich bietet sich dem Betrachter dabei eine geschlossene Frontoptik aus Filzmaterial ohne erkennbare Lamellenstruktur. Wie selbstverständlich passt sich diese Filzjalousie beim Verschieben jeder geraden und gebogenen Struktur der Regalelemente an. Die Jalousien gleiten vor dem Korpus und lassen sich durchgehend über mehrere Regalelemente verschieben. So entsteht ein Wechsel zwischen offenen, transparenten Durchblicken und geschlossenen Fronten.

Es bilden sich bewegliche Räume, die für unterschiedliche Bürotätigkeiten genutzt werden können: als Servicezone, als Kommunikationsinsel, als Rückzugsbereich für konzentriertes Arbeiten und natürlich auch als zentraler Stauraum oder als Bibliothek.

The core of the system is the unique blinds principle. Observers can see a full front made of felt fabric without a perceptible louvre structure. These felt louvre blinds mould naturally to the straight and curved structure of the shelf elements. The blinds slide in front of the carcass and can be pushed across several shelf elements at the same time. This creates an alternating structure of transparent views and closed fronts.

Flexible rooms can be designed that are suitable for a wide range of office activities - as a service area or communication island, as a privacy area for concentrated work and also naturally as a central storage area or library.





SPACE Layout 1

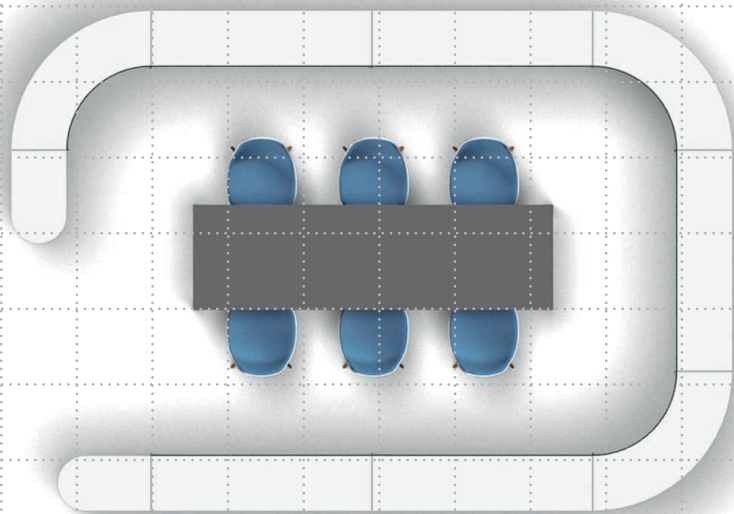

480

333

**Elemente**

Regale 4 OH: 5 x shelf147 | 3 x round90 | 2 x final

Slider 4 OH: 5 x 147,2 | 3 x 87,6

Boxen/Back Panels



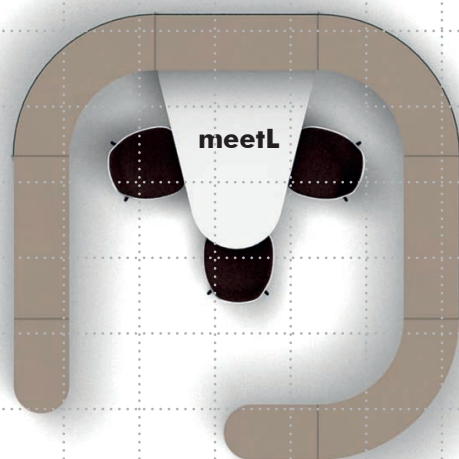

294

294

SPACE Layout 2

**Elemente**

Regale 4 OH: 2 x shelf107 | 1 x meetL107 | 3 x round90 | 2 x final147

Slider 4 OH: 2 x 147,2 | 2 x 107,5

Boxen/Back Panels



## SPACE Layout 3

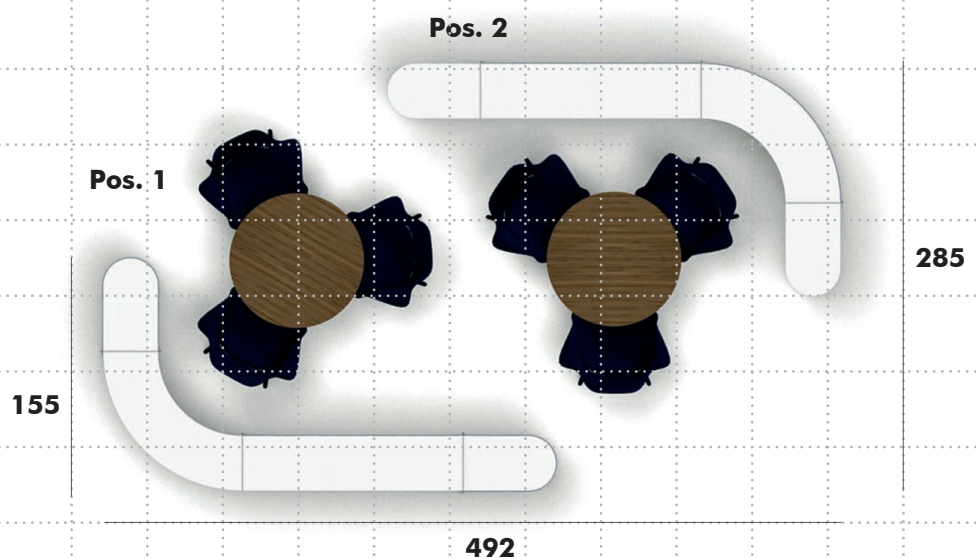

### Elemente Pos. 1

Regale 3 OH: 1 x shelf147 | 1 x round90 | 2 x final  
 Slider 3 OH: 3 x 147,2  
 Back Panel

### Elemente Pos. 2

Regale 4 OH: 1 x shelf147 | 1 x round90 | 2 x final  
 Slider 4 OH: 2 x 147,2  
 Boxen/Back Panel



280

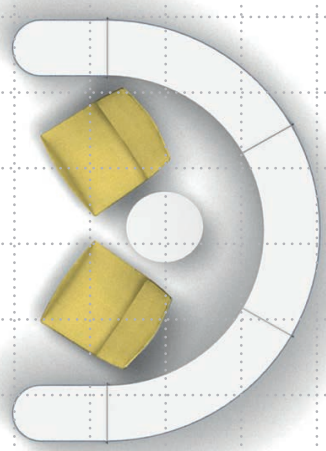

201

## SPACE Layout 4

**Elemente**

Regale 4 OH: 3 x round60 | 2 x final  
 Slider 4 OH: 2 x 147,2 | 3 x 107,5



## SPACE Layout 5

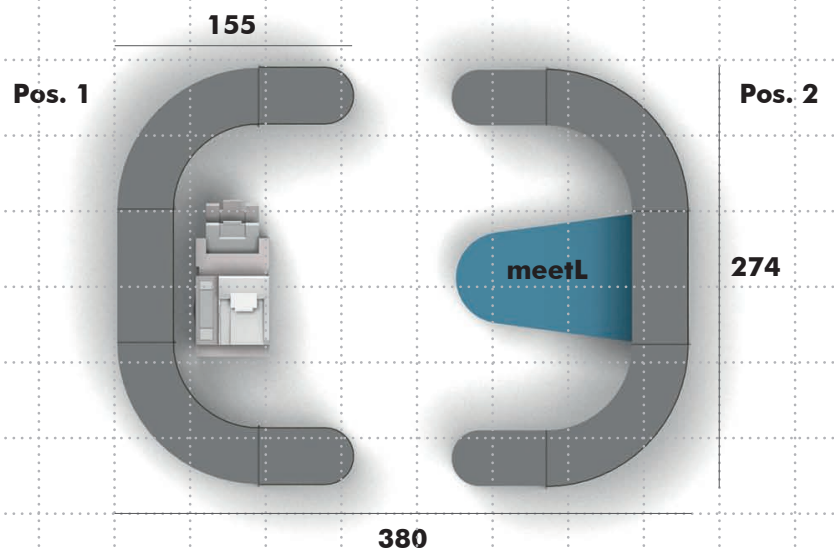

### Elemente Pos. 1 - Service Point Technik

Regale 4 OH: 1 x shelf87 | 2 x round90 | 2 x final  
Slider 4 OH: 2 x 147,2 | 3 x 87,6

### Elemente Pos. 2 - Service Point Post

Regale 4 OH: 1 x meetL87 | 2 x round90 | 2 x final  
Slider 4 OH: 2 x 147,2 | 1 x 87,6  
Back Panels



## SPACE Layout ' ʹ



294

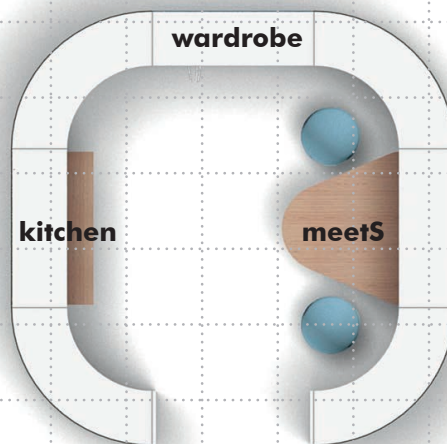

294

### Elemente - Service Point Privat

Regale 4 OH: 1 x kitchen107 | 1 x wardrobe107 | 1 x meetS107 | 4 x round90  
 Slider 4 OH: 4 x 147,2 | 3 x 107,5 | 2 x Abschlusseiten



## FLOW - SIT

basic<sup>flow</sup> bietet neben dem reinen Nutzen eines Stauraummöbels die Möglichkeit, mit geraden und gebogenen Regalen Räume zu gestalten und zu strukturieren.

Dabei kann durch den Einsatz von verschiebbaren Jalousieelementen aus Filz die offene Regalstruktur auch partiell verschlossen werden. Der konstruktive Aufbau der Jalousie hilft störenden Umgebungslärm zu absorbieren. Somit entstehen visuell und akustisch abgeschirmte Räume für Rückzugsmöglichkeiten in den sonst offenen Bürostrukturen.

In addition to providing storage, the basic<sup>flow</sup> range features straight and curved elements for designing and structuring rooms.

The open shelf structure can also be partly closed with sliding blinds made of felt. The design of the blind helps to absorb disruptive ambient noise. Visually and acoustically shielded spaces are therefore created to provide areas where people can withdraw and find privacy in the otherwise open office structures.



Back Panel

Das Sortiment von basic<sup>flow</sup> umfasst gerundete Regale 60° und 90° „round 60“ und „round 90“ und gerade Regale „shelves“. Den Abschluss bildet das Regal „final“. Dieses ist an der gerundeten Seite umlaufend mit einer Führungsschiene versehen und ermöglicht so den Richtungswechsel der Jalousie „slider“. Die Sitzpodeste „sit“ und das Tischmodul „coffee table“ sind additiv und nicht fest mit den Regalen verbunden.

Die organische Formensprache der Gesamtstruktur in Verbindung mit dem Material Filz erzeugt ein inspirierendes Arbeitsumfeld und eine angenehme Atmosphäre im Raum.

The basic<sup>flow</sup> range features the “round 60” and “round 90” curved 60° and 90° shelves as well as the straight “shelves”. The “final” shelf rounds off the portfolio. On the round side this is equipped with a guide rail and therefore enables a change in direction of the “slider” blind. The “sit” seating elements and the “coffee table” are designed as add-on options and are not connected to the shelves.

The organic design concept of the overall structure combined with felt creates an inspiring working environment and a pleasant atmosphere in the room.





SIT Layout 1



SIT Layout 2

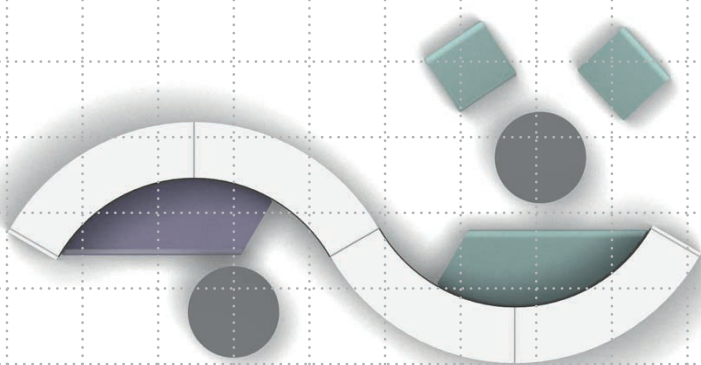

455

158



142

280

**Elemente**

Regale 3 OH: 4 x round60  
 Slider 3 OH: 4 x 107,5 | 2 x Abschlusseiten  
 Sitzpodeste: 2 x sit60, 2 x sit  
 Tische: 2 x coffee table

**Elemente**

Regale 4 OH: 3 x round60  
 Slider 4 OH: 3 x 107,5 | 2 x Abschlusseiten  
 Sitzpodeste: 2 x sit60  
 Tische: 1 x coffee table





SIT Layout 3

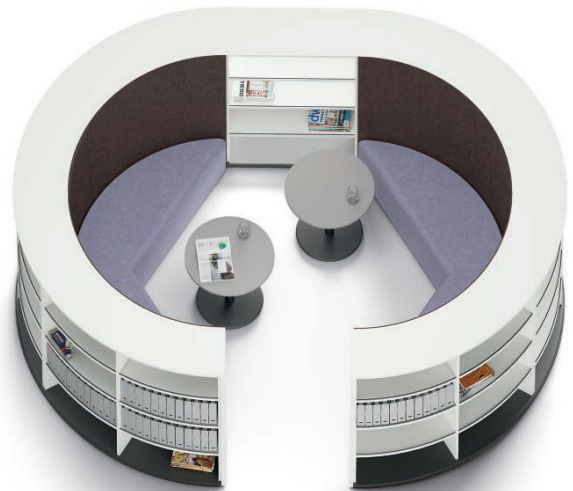

SIT Layout 4

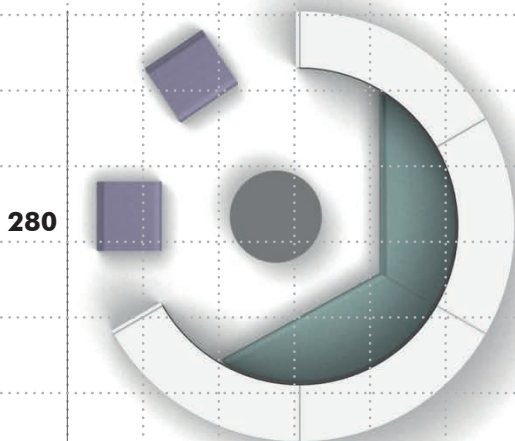

280

262



280

367

**Elemente**

Regale 4 OH: 4 x round60  
 Slider 4 OH: 4 x 107,5 | 2 x Abschlussseiten  
 Sitzpodeste: 2 x sit60, 2 x sit  
 Tische: 1 x coffee table

**Elemente**

Regale 4 OH: 1 x shelf87 | 6 x round60  
 Slider 4 OH: 6 x 107,5 | 2 x Abschlussseiten  
 Sitzpodeste: 4 x sit60  
 Tische: 2 x coffee table



SIT Layout 5



SIT Layout 6

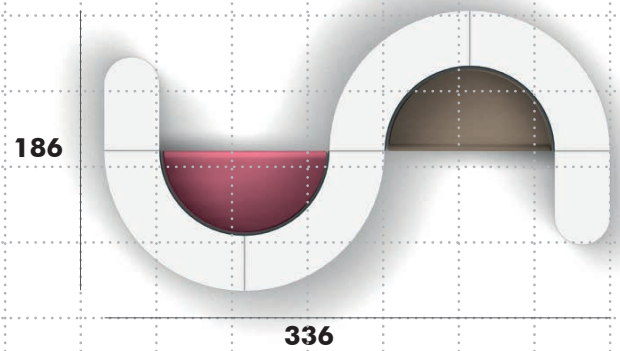
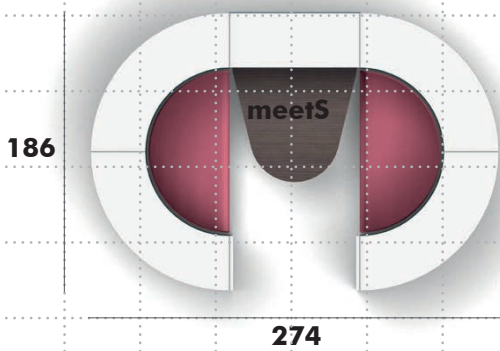

**Elemente**

Regale 4 OH: 1 x meetS87 | 4 x round90  
 Slider 4 OH: 5 x 87,6 | 2 x Abschlusseiten  
 Sitzpodeste: 2 x sit90

**Elemente**

Regale 4 OH: 4 x round90 | 2 x final  
 Slider 4 OH: 4 x 87,6  
 Sitzpodeste: 2 x sit90



SIT Layout 7



SIT Layout 8

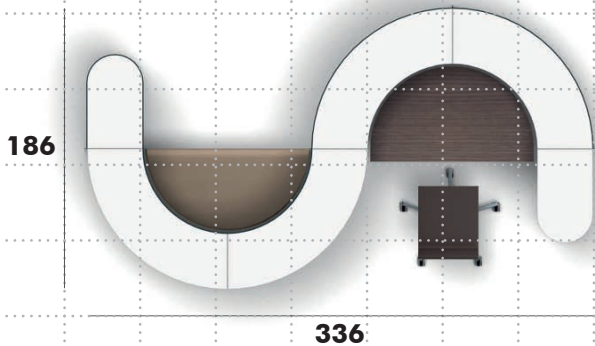

262

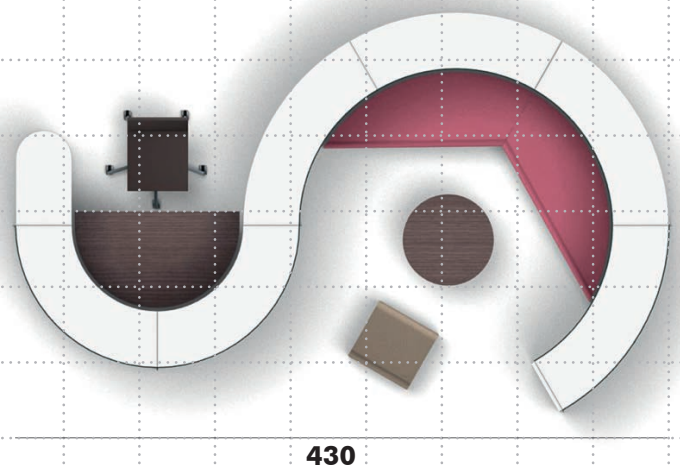

**Elemente**

Regale 3 OH: 4 x round90 | 2 x final  
 Slider 3 OH: 3 x 147,2 | 2 x 87,6  
 Sitzpodeste: 1 x sit90  
 Tische: 1 x workstation

**Elemente**

Regale 4 OH: 2 x round90 | 4 x round60 | 1 x final  
 Slider 4 OH: 3 x 147,2 | 4 x 107,5 | 1 x Abschlusseite  
 Sitzpodeste: 2 x sit60 | 1 x sit  
 Tische: 1 x workstation | 1 x coffee table

# FLOW - FOCUS





Flow - Focus ist eine Kombination aus offenen Regalen und Tischelementen, den "workstations". 3 oder 4 ordnerhohe slider verschließen die Regale partiell und bieten so Rückzugsmöglichkeiten für konzentriertes Arbeiten. Die Verschiebbarkeit der slider ermöglicht dem Nutzer aber auch, Teilbereiche wieder zum Raum hin zu öffnen und damit Durchblicke zu schaffen.

In den geraden shelves lassen sich verschließbare Wertfächer „boxen“ integrieren, die Stauraum zur privaten Nutzung bieten. Die boxen geben dem Anwender die Möglichkeit, die offenen Regalstrukturen teilweise zu schließen und gleichzeitig gestalterische Akzente zu setzen.

Regal Final



Flow - Focus is a combination of open shelves and table elements, the "workstations". Sliders with a height of three or four files partially close off the shelves, creating quiet areas where people can concentrate. The mobility of the sliders also enables users to partially open spaces to the general area for visual transparency.

Lockable boxes can be integrated into the straight shelves that provide storage space for private use. The boxes enable users to partially close the open shelf structures and can be used at the same time to make a design statement.



## FOCUS Layout 1

## FOCUS Layout 2

186

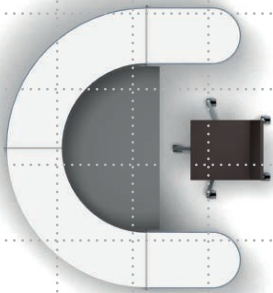

155

186

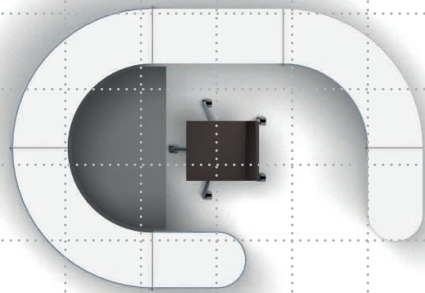

274

### Elemente

Regale 3 OH: 2 x round90 | 2 x final  
 Slider 3 OH: 2 x 147,2 | 2 x 87,6  
 1 x workstation

### Elemente

Regale 4 OH: 1 x shelf87 | 3 x round90 | 2 x final  
 Slider 4 OH: 3 x 147,2 | 1 x 87,6  
 1 x workstation  
 Boxen/Back Panels



## FOCUS Layout 3

## FOCUS Layout 4

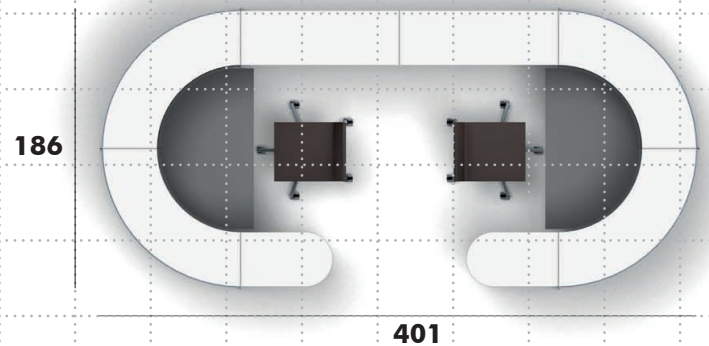
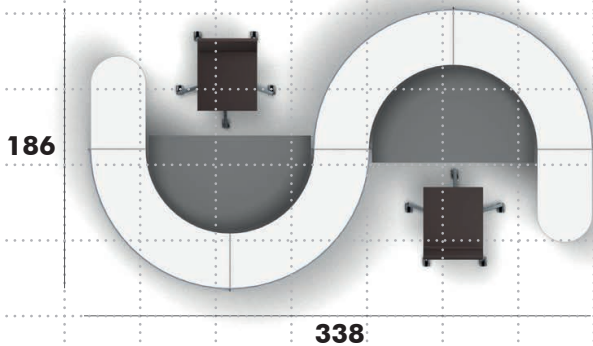

### Elemente

Regale 3 OH: 4 x round90 | 2 x final  
 Slider 3 OH: 4 x 147,2  
 2 x workstation  
 Boxen

### Elemente

Regale 4 OH: 2 x shelf107 | 4 x round90 | 2 x final  
 Slider 4 OH: 4 x 147,2 | 2 x 107,5  
 2 x workstation  
 Boxen/Back Panels

# FLOW - COUNTER



Moderne Bürokonzepte bieten dem Mitarbeiter differenzierte Orte für Kommunikation, für spontane Begegnungen und den informellen Gedankenaustausch. basic<sup>flow</sup> - Counterlösungen übernehmen einerseits die Funktion eines Stauraummöbels, andererseits sind die 3 ordnerhohen Regaleinheiten aber auch Meeting-Point, Theke oder Arbeitsplatz in Stehhöhe. Auch der klassische Counter als Anlaufstation im Empfang kann mit basic<sup>flow</sup>- Regalen jederzeit umgesetzt werden. Der Wechsel zwischen gebogenen und geraden Regalelementen ermöglicht eine Vielzahl von unterschiedlichen Konfigurationen und so wird basic<sup>flow</sup> zum integralen Bestandteil einer lebendigen Bürowelt.

Contemporary office concepts offer personnel separate spaces for communication, spontaneous meetings and informal communication.

basic<sup>flow</sup> counter solutions act on the one hand as furniture for storage, on the other the shelf units with a height of three files also serve as meeting points, counters or standing-height workplaces. basic<sup>flow</sup> shelves can also be used to create a classic counter in reception areas. Alternating curved and straight shelf elements can be combined in a wide range of different combinations, and basic<sup>flow</sup> therefore becomes an integral element of a vibrant office environment.





Boxen



## COUNTER Layout 1

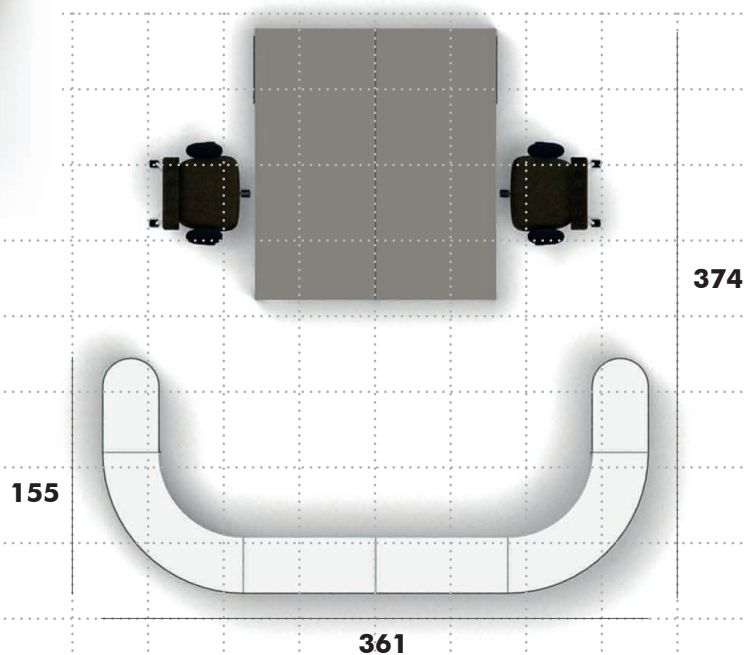

### Elemente

Regale 3 OH: 2 x shelf87 | 2 x round90 | 2 x final

Slider 3 OH: 4 x 147,2 | 2 x 87,6

Boxen



308

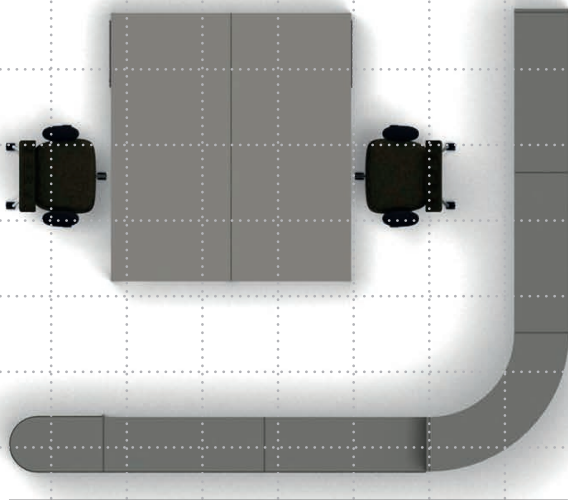

370

## COUNTER Layout 2

### Elemente

Regale 4 OH: 2 x shelf107 | 1 x round90

Regale 3 OH: 2 x shelf107 | 1 x final

Slider 3 OH: 1 x 147,2 | 2 x 107,5 | 2 x Abschlusseiten 4 OH

Boxen/Back Panels



COUNTER Layout 3

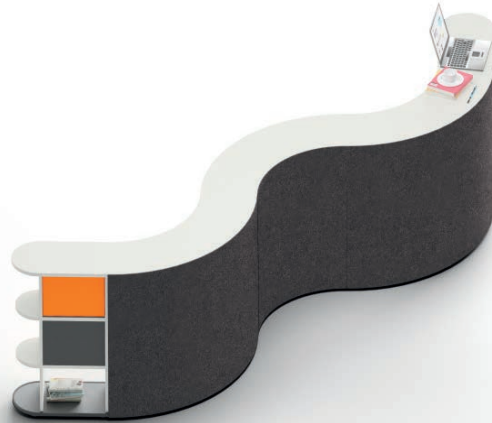

COUNTER Layout 4

214



165

90

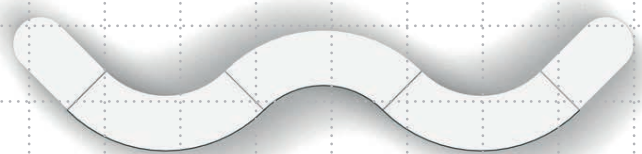

415

**Elemente**

Regale 3 OH: 2 x round60 | 1 x round90  
 Slider 3 OH: 3 x 147,2 | 2 x Abschlussseiten

**Elemente**

Regale 3 OH: 3 x round90 | 2 x final  
 Slider 3 OH: 2 x 147,2 | 1 x 87,6  
 Box/Back Panel



COUNTER Layout 5



COUNTER Layout 6

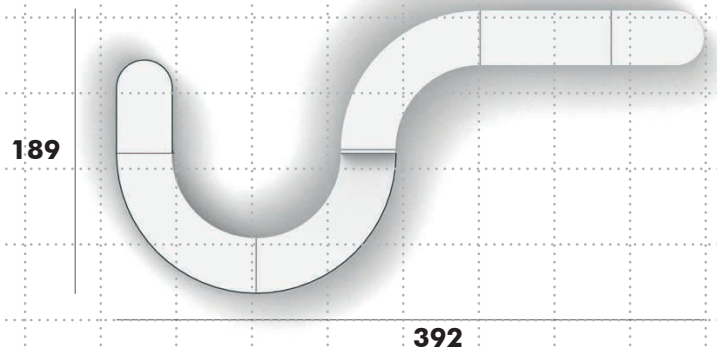
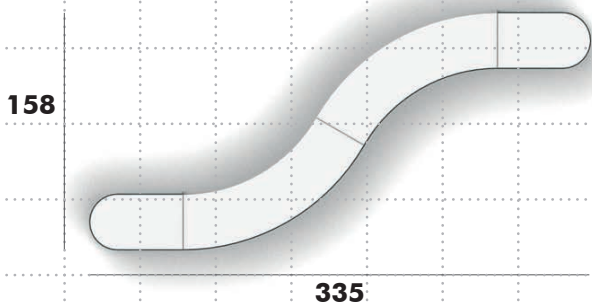

**Elemente**

Regale 3 OH: 2 x round60 | 2 x final  
 Slider 3 OH: 3 x 147,2 | 1 x 107,5

**Elemente**

Regale 3 OH: 2 x round90 | 1 x final  
 Regale 4 OH: 1 x shelf87 | 1 x round90 | 1 x final  
 Slider 3 OH: 3 x 147,2 | 1 x Abschlusseite 4 OH  
 Boxen/Back Panels

# SORTIMENT RANGE

## ROUND

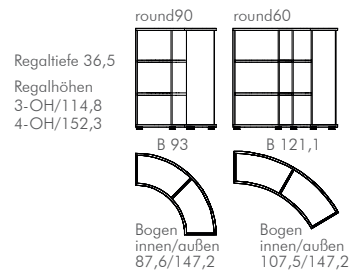

## SHELF

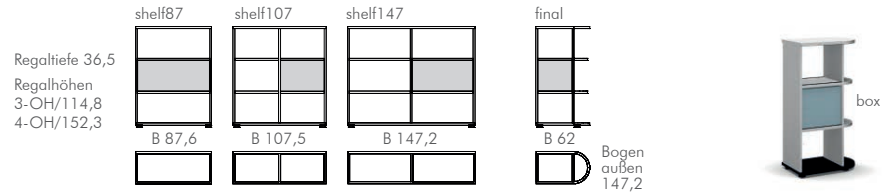

## SLIDER

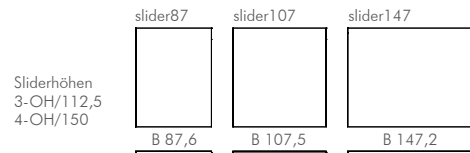
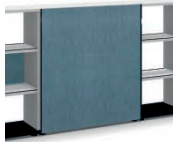

## WARDROBE / KITCHEN

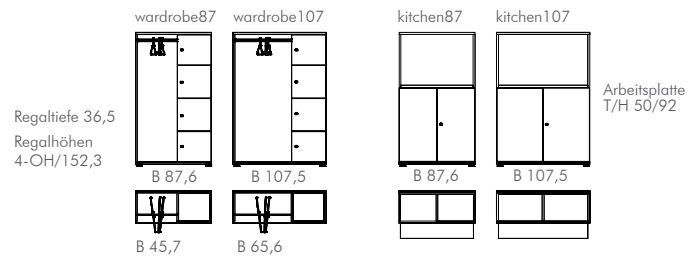

## MEET

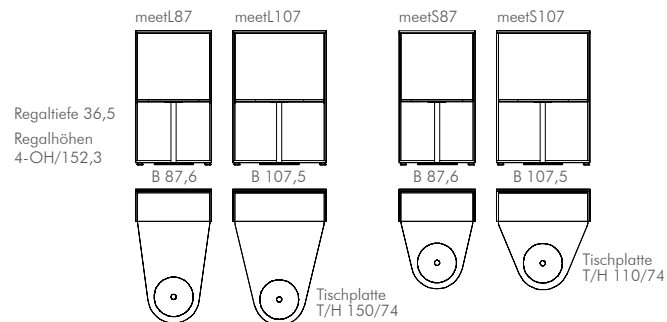

## WORKSTATION / COFFEE TABLE

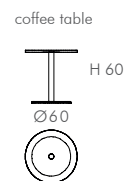
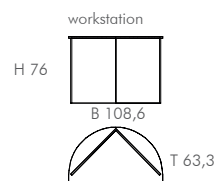

## SIT

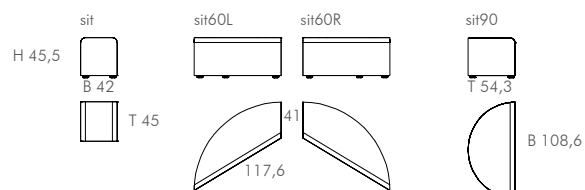

# MATERIAL UND FARBE MATERIAL AND COLOR

## UNIDEKOR SINGLE COLOUR DECOR

SHELVES  
TABLETOPS  
BOXEN  
DOORS

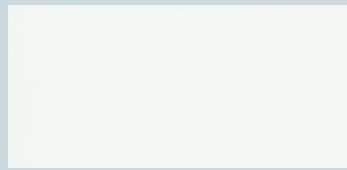

premiumweiß premium white

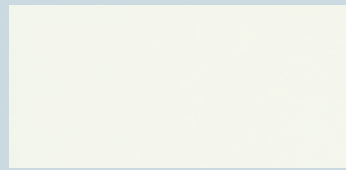

weiß white

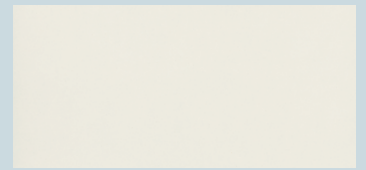

weißgrau white grey

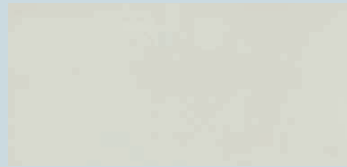

lichtgrau light grey



silber silver



basaltgrau basalt grey

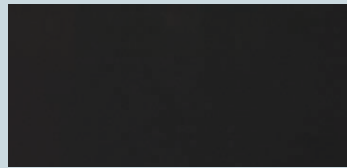

graphit graphite

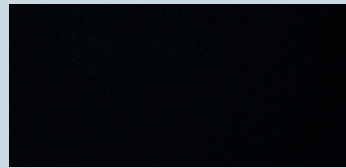

schwarz black

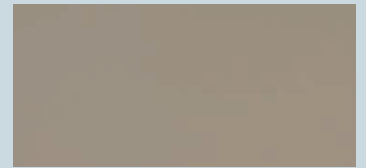

steingrau stone grey

## FILZ FELT

SLIDER  
BACK PANELS

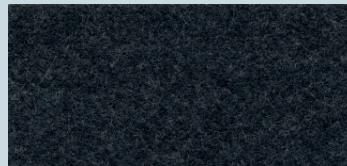

anthracite

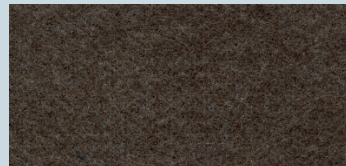

ecobrown

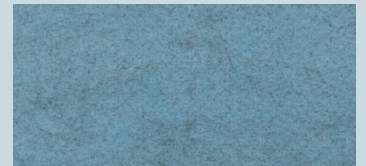

lightblue

## HOLZDEKOR WOOD MELAMINE

TABLETOPS  
BOXEN  
DOORS



Ahorn maple

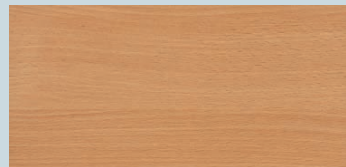

Buche beech



Eiche hell light oak



Eiche grau oak grey



Kirschbaum Romana  
cherry romana

## ECHTHOLZFURNIER WOOD VENEER

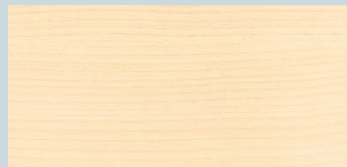

Ahorn maple

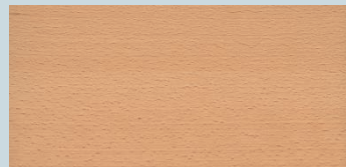

Buche beech



Eiche hell light oak



Kirschbaum cherry



Nussbaum walnut

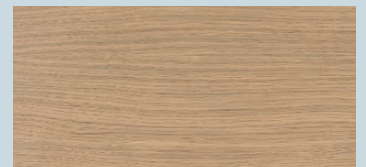

Eiche weißpigmentiert  
oak whitepigmented

## LACK LACQUER RAL/NCS/PANTONE/SIKKENS



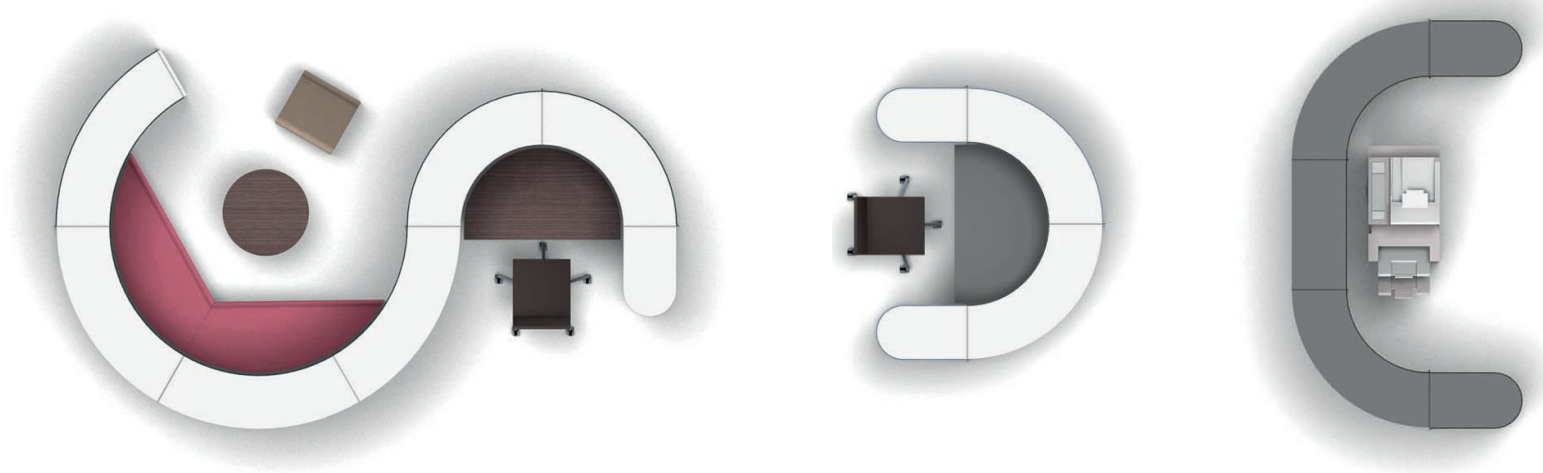

werner works Vertriebs GmbH  
Königsberger Straße 7-11  
D-32339 Espelkamp

t. + 49.5772.201 0  
f. + 49.5772.201 70

info@werner-works.de  
www.werner-works.de